



PARASNATH ALUMINIUM

THINK ALUMINIUM. THINK PARASNATH



Texture Wood

Wooden : 3mm, 4mm | HPL 6mm



WT-51 Indoteak Texture



WT-51 Indoteak Texture





WT-52 Zebrano



WT-53 Smoke Walnut



 Available in 3MM & 4MM Exterior Grade

 Available in 6MM HPL (One Side) Exterior Grade

Elegant Wood

Wooden : 3mm, 4mm | HPL 6mm



WP-81 Rail Track



WP-81 Rail Track



WP-82 Wood Matt



WP-82 Wood Matt



Anti Scratch Wood

Wooden : 3mm, 4mm | HPL 6mm



W-41 Wood Grains



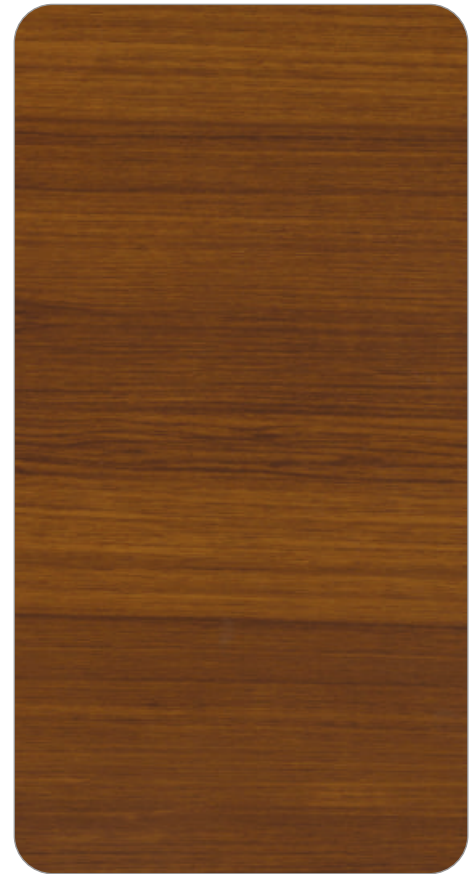

W-42 Teak Wood





W-43 Burma Teak



W-42 Teak Wood

-  Available in 3MM & 4MM Exterior Grade
-  Available in 6MM HPL (One Side) Exterior Grade

-  Available in 6MM HPL (One Side & Both Side) Exterior Grade
-  Available in Partition (4 Feet)

Classy Wood

Wooden : 3mm, 4mm | HPL 6mm

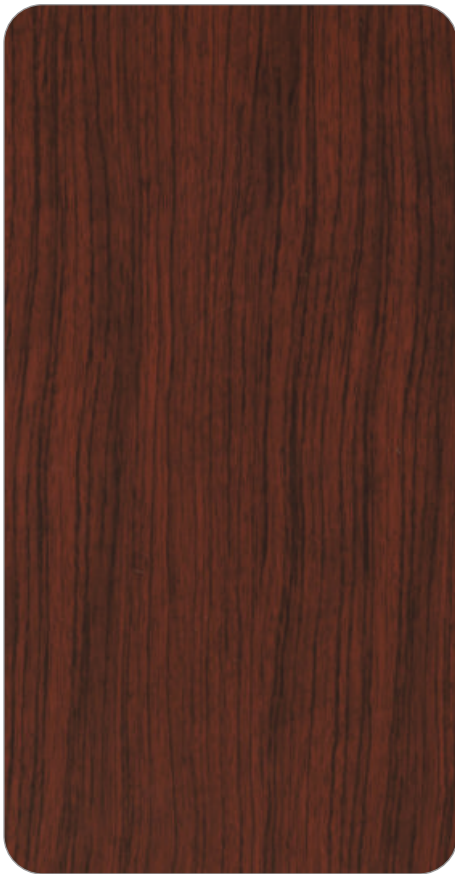

W-34 Mahagony



W-35 Nayna Teak



W-46 Wenge



W-48 Rose Wenge



W-38 Dark Oak



W-39 Cherry Beech



Classy Wood

Wooden : 3mm, 4mm | HPL 6mm

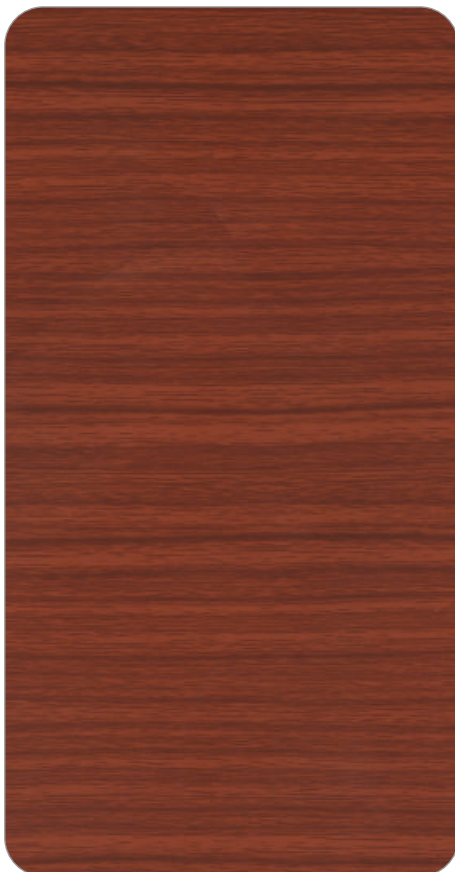

W-47 Sapeli



W-44 Moby Sapeli

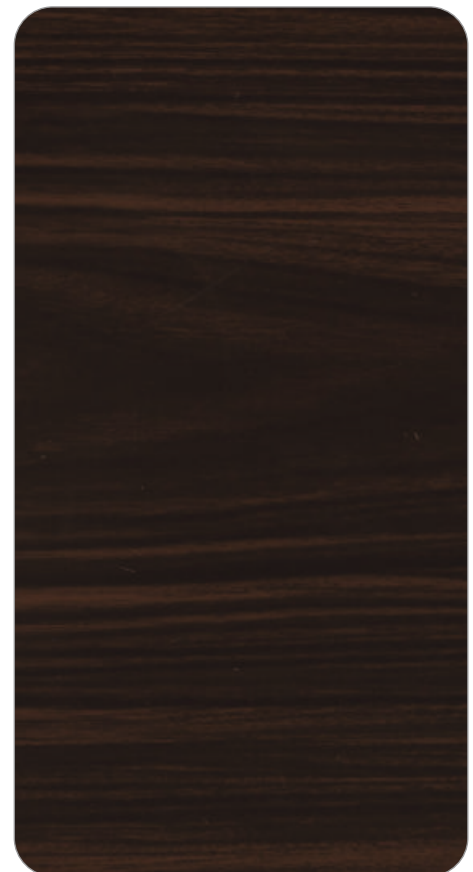

W-45 African Ebony



Classy Wood

Wooden : 3mm, 4mm | HPL 6mm



W-36 Golden Maple 



W-40 Oriental Walnut 



W-37 Rose Wood 



W-49 Indo Walnut 

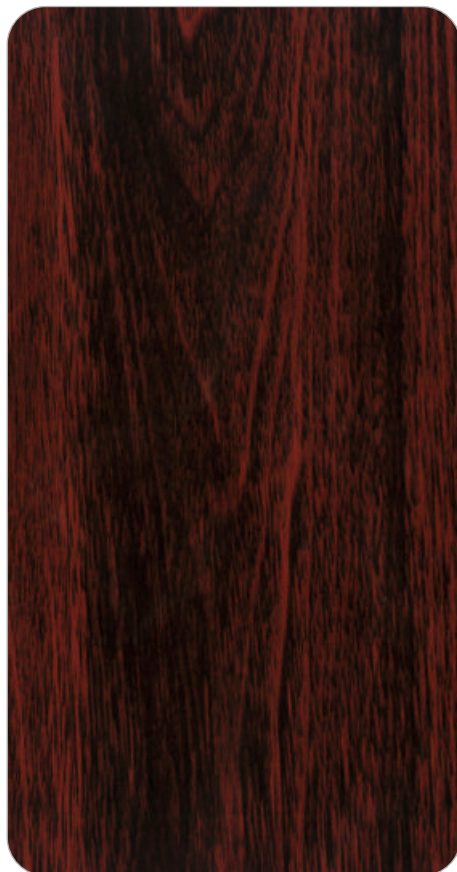

W-50 Elegant Teak 



W-51 Dark Ebony 

Euro Sand

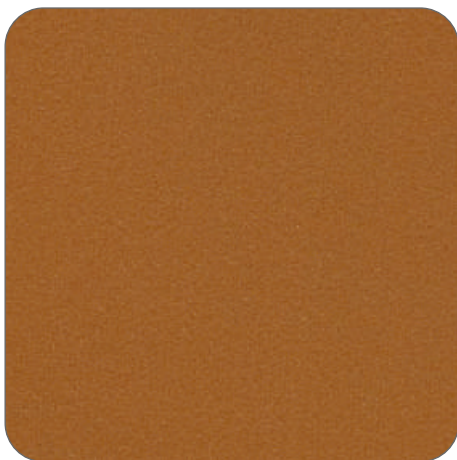

S-71 Copper







S-74 Grey



S-73 Red



-  Available in 3MM & 4MM Exterior Grade
-  Available in 6MM HPL (One Side) Exterior Grade

-  Available in Partition (4 Feet & 3 Feet)
-  Available in Partition (4 Feet)

Luxe Marble

Marble : 3mm, 4mm | HPL 6mm

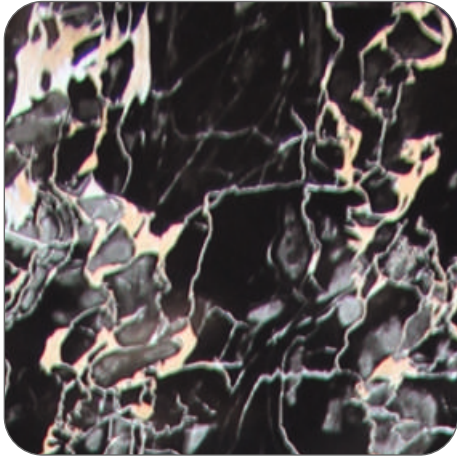

MP-61 Golden Portoro



MP-62 Tiger Onyx

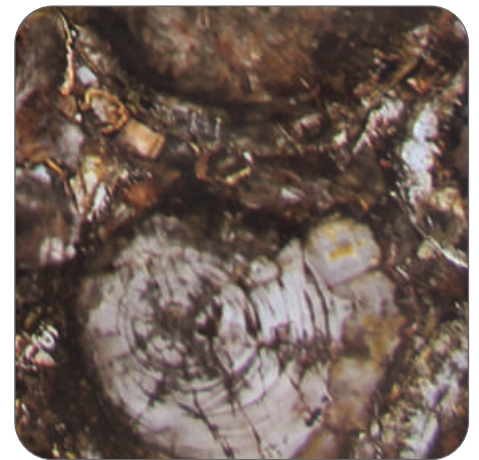

MP-63 Volcano Onyx



MP-64 Bricky



Classy Marble

Marble : 3mm, 4mm | HPL 6mm

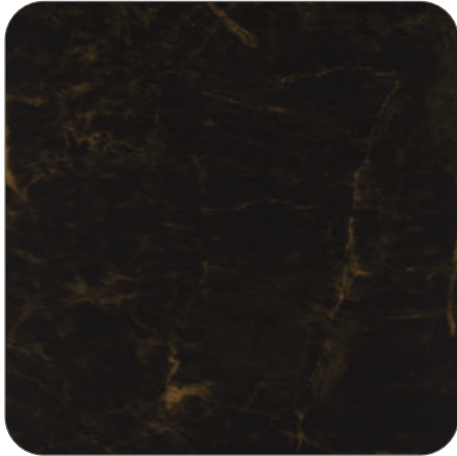

M-32 Classic Onyx ■ ■ ■

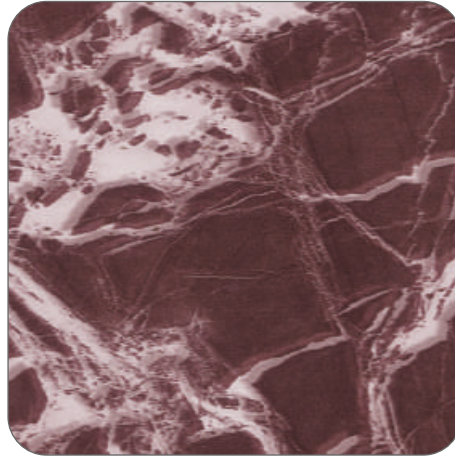

M-33 Rosse Levento ■ ■

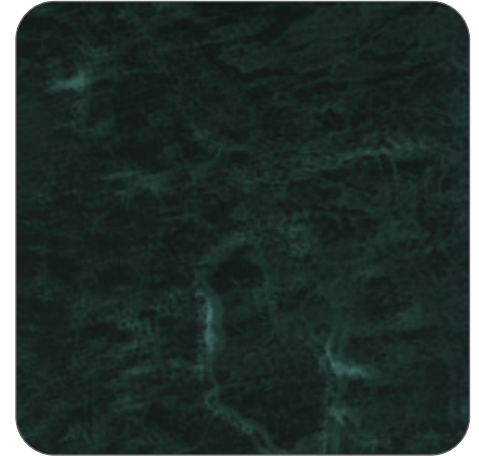

M-34 Verde Issorie ■ ■

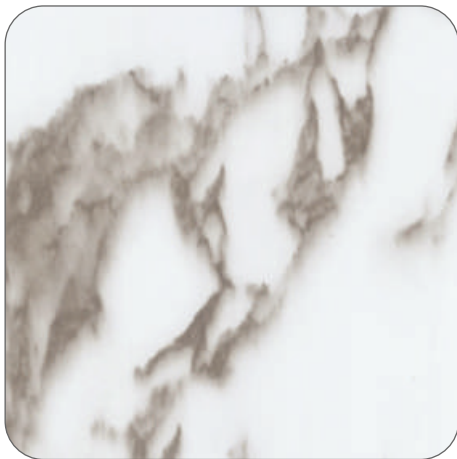

M-35 White Marble ■ ■ ■



M-39 Pearl Granite ■ ■

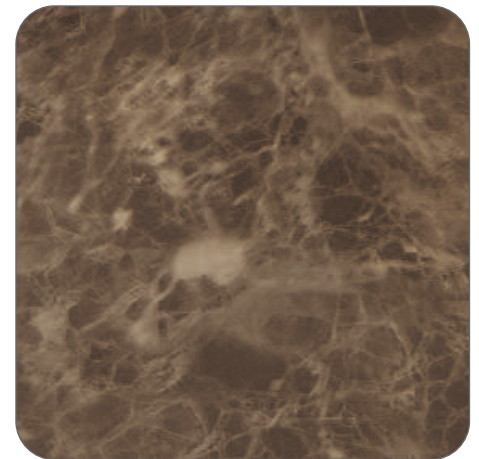

M-40 Brown Marble ■ ■ ■

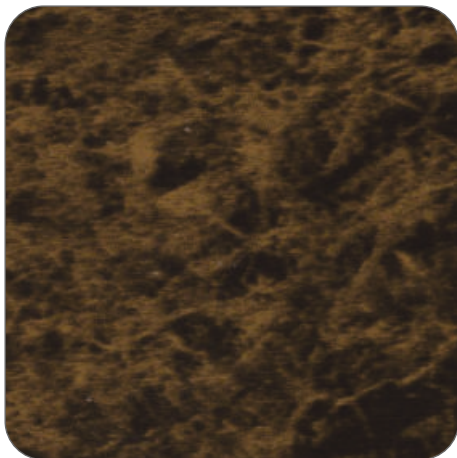

M-36 Dark Onyx ■ ■ ■

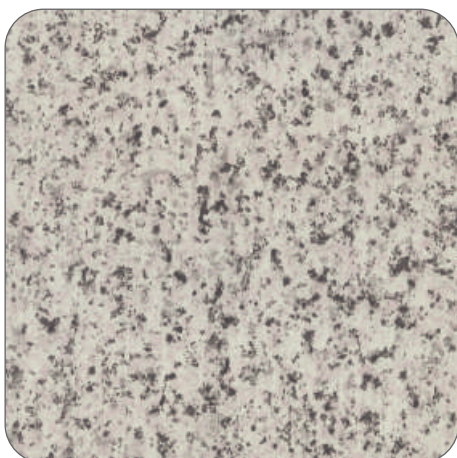

M-37 White Granite ■ ■



MP-62 Tiger Onyx

MP-61 Golden Portoro

■ Available in 3MM & 4MM Exterior Grade ■ Available in 6MM HPL (One Side) Exterior Grade

■ Available in 6MM HPL (One Side & Both Side) Exterior Grade

■ Available in Partition (4 Feet)

Vivid Colours



EX-01 Bright Silver

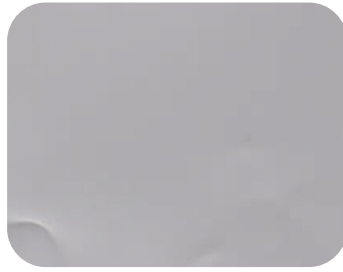

EX-04 Metallic Silver



EX-02 Champagne Gold



EX-05 Champagne Silver



EX-09 Egyptian Bronze



EX-08 Classic Gold



EX-03 Copper Metallic



EX-06 Pearl Copper



EX-30 Magic Gold



EX-11 Silver Black



EX-12 Silver Blue



EX-07 Jade Green

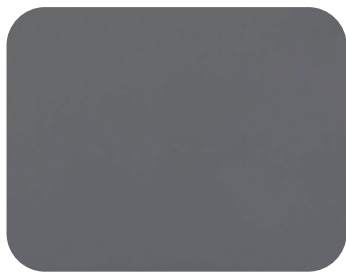

EX-22 Slate Grey



EX-31 New Black



EX-34 Glossy Black



EX-16 Jet Black

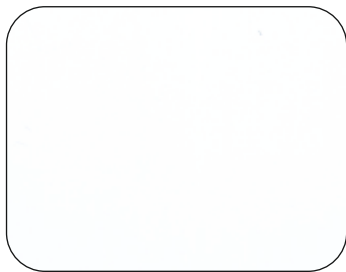

EX-33 Glossy White

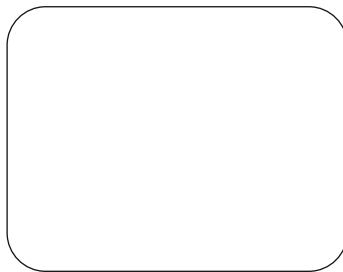

EX-41 Ice White

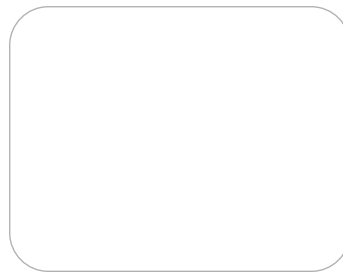

EX-18 Pure White



EX-21 Ivory White



EX-17 Lemon Yellow



EX-25 Signal Yellow



EX-19 Refreshing Orange

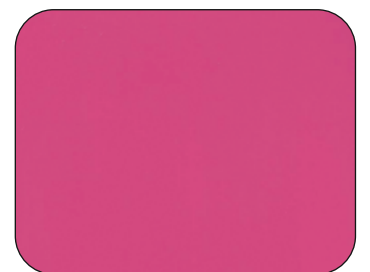

EX-43 Barbie Pink

Vivid Colours



EX-37 Glossy Red



EX-15 Signal Red



EX-39 Bright Red



EX-10 Wine Red



EX-40 Burgundy



EX-35 Brick Red



EX-38 Chocolate Brown



EX-32 Lake Blue



EX-24 Signal Blue



EX-20 Navy Blue

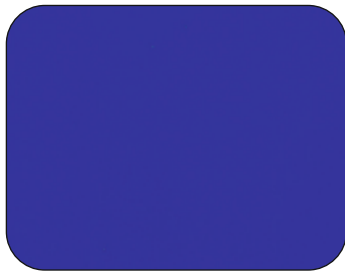

EX-44 Samsung Blue

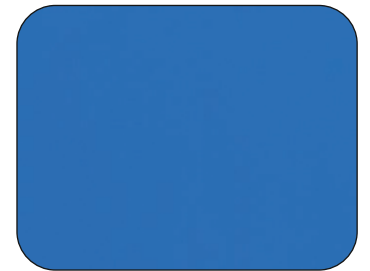

EX-46 Vivo Blue



EX-36 Parrot Green



EX-23 Emerald Green



EX-26 Refreshing Green



EX-45 Oppo Green



EX-42 Marine Blue

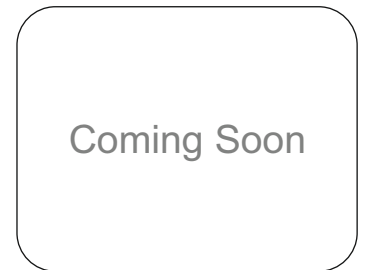

EX-47 Coming Soon

- Available in 2MM, 3MM & 4MM Exterior, Interior & RG Grade
- Available in 2MM, 3MM & 4MM Exterior & Interior Grade
- Available in 3MM & 4MM Exterior Grade
- Available in Partition (4 Feet)
- Available in Partition (4 Feet & 3 Feet)
- Available in (.50) Exterior Grade
- Available in (5 Feet) Exterior Grade
- Available in 6MM HPL (One Side) Exterior Grade

Sparkle Collection



M-31 Star Galaxy Granite ■ ■



M-38 Galaxy White ■ ■



M-41 Galaxy Red ■ ■



Electra Collection



EX-13 Silver Mirror ■ ■

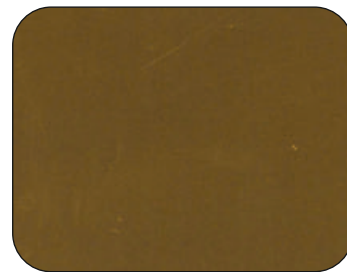

EX-14 Gold Mirror ■ ■



EX-48 Copper Mirror ■ ■

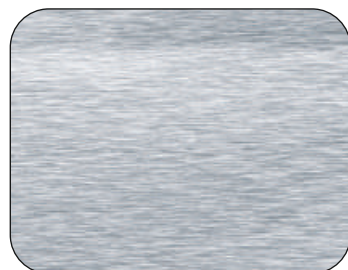

EX-27 Silver Brush ■ ■ ■

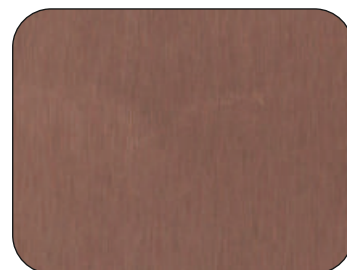

EX-28 Copper Brush ■ ■

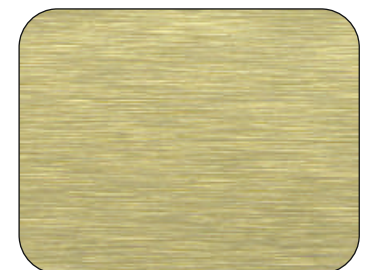

EX-29 Gold Brush ■ ■

Available in :

- 3MM & 4MM Exterior Grade
- 2MM, 3MM & 4MM Ext. & Int. Grade
- 2MM, 3MM & 4MM Exterior Grade
- 6MM HPL (One Side) Exterior Grade
- (.50) Exterior Grade
- Available in 6MM HPL (One Side & Both Side) Exterior Grade

Dimensions / Specifications

Standard Width : 1220 MM
 Available Width : 1220 MM, 1525 MM
 Standard Length : 2440 MM, 3050 MM, 3660 MM
 Available Length : ANY LENGTH UPTO 6100 MM
 Panel Thickness : 2 MM TO 6 MM

*Length & thickness can be customized on special request

Product Tolerance

Length : ± 5 MM
 Width : ± 5 MM
 Thickness : ± 0.2 MM



Fire Retardant ACP
 FR Grade available with A2, B1 & B2 Grade with all third party test certificates. This series is can be produced on demand.

Transport, Handling & Storage

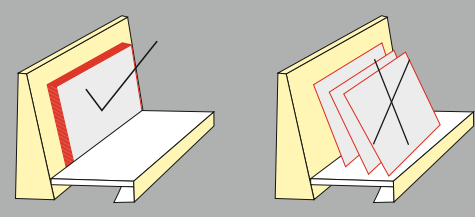

Fixing Method

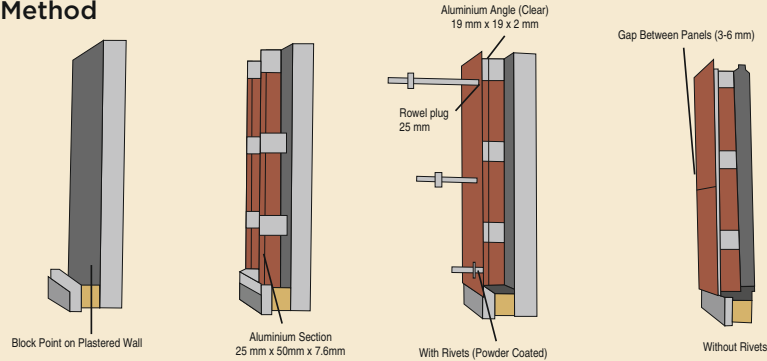

Aluminium Angle (Clear) 19 mm x 19 x 2 mm
 Rivet plug 25 mm
 Gap Between Panels (3-6 mm)

INDOBOND GROUP PRODUCTS

- Aluminium Composite Panels
- ACP-HPL
- ACP-Highlighters (for Interior Decoration Only)
- ACP-Premium Highlighters (for Interior Decoration Only)
- Aluxury Royal UV Marbled (for Interior Decoration Only)
- Aluxury Royal PVC Laminates (for Interior Decoration Only)

- Shades may vary from batch to batch
- Please match the batch number before installation. Company liability does not arise if the shade mis match due to batch variation.

Applications Exterior

- Commercial Building
- Wall Cladding
- Balcony Cladding
- Rafters
- Attic Cladding
- Canopy
- Outdoor Cladding
- Multiplexes Mall
- Hotels & Restaurants
- Hospital & Health Care
- Airport
- Metro Stations
- Railway Stations
- Signages
- Toll Tax Gate
- Gate Elevation
- Show Room
- Petrol Pump
- Factory Building
- Facades
- Pergola
- Fence
- Banks & ATMS
- Corporate Office
- Sport Stadium & Hall

Interiors

- Pillars And Coloumns
- False Ceiling
- Partitions
- Bus Body
- Furniture
- Railings
- Ceiling
- Interior Walls
- Modular Kitchens
- Portals
- Flush Door
- Louvers

Advertising

- Display Units
- Glowsign Boards

Salient Features

- Light Weight & Rigid
- Excellent Flatness
- Eco Friendly
- Fire Retardent
- Water Resistance
- Easy To Clean
- Easy To Install
- Wide Range of Colours & Patterns
- Fully Recyclable
- Sound & Thermal Resistant
- Cost Effective
- Modern Looks
- Flexible
- High Strength
- Impact Resistance
- Vibration Dampening
- Kynar 500 PVDF Coating



PARASNATH ALUMINIUM

THINK ALUMINIUM. THINK PARASNATH

**Corporate Office: "Ecospace Business Tower"
Tower 5A, 3rd Floor, Suit NO.8 , kolkata-700160**

**Regd. Office: Ajit Mansion 10/1/1C Kalakar Street,
1st Floor, Kolkata-700007**

Shop Address: 42/1 Strand Road, Kolkata-700007

**Phone : +91 9836622666 / 8617263130/
9331199929 / 9831640153**

Email: info@parasnathaluminium.com