

TEXTILE MACHINERY

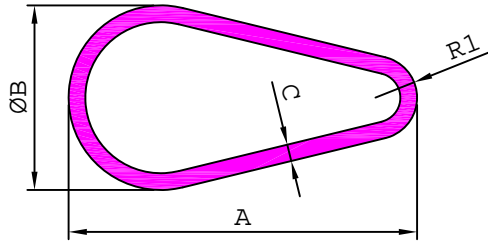

| SL. No. | Section No. | A | ØB | C | R1 | Weight kg/m |
|---------|-------------|-------|-------|------|------|-------------|
| 1 | 24701 | 38.25 | 27.94 | 1.27 | 8.41 | 0.343 |
| 2 | 24713 | 39.40 | 21.00 | 1.20 | 4.45 | 0.303 |

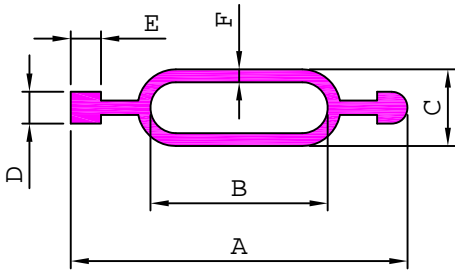

| SL. No. | Section No. | A | B | C | D | E | F | Weight kg/m |
|---------|-------------|-------|-------|-------|------|------|------|-------------|
| 1 | 24735 | 47.00 | 30.00 | 7.60 | 2.50 | 2.40 | 0.70 | 0.180 |
| 2 | 24732 | 60.00 | 41.00 | 8.40 | 3.50 | 2.65 | 0.85 | 0.287 |
| 3 | 24717 | 60.00 | 42.00 | 10.20 | 4.00 | 3.00 | 1.10 | 0.376 |

TEXTILE MACHINERY

17516

0.121 kg/m

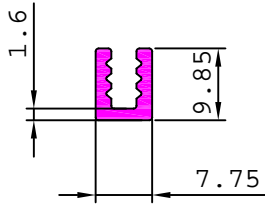

17525

0.084 kg/m

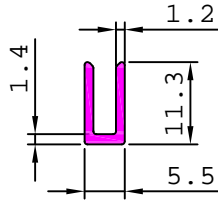

17526

0.080 kg/m

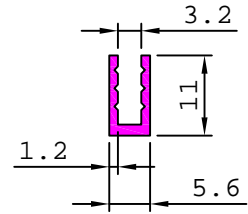

17567

0.124 kg/m

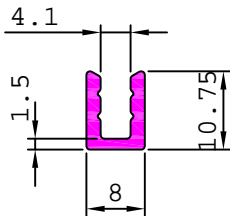

17568

0.194 kg/m

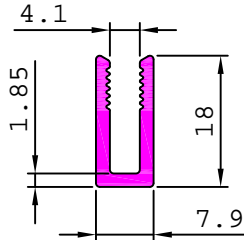

17577

0.140 kg/m

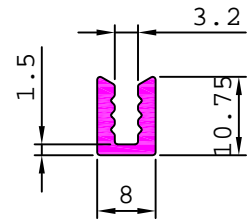

17620

0.133 kg/m

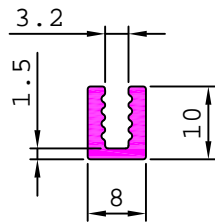

17623

0.107 kg/m

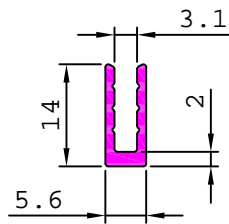

17639

0.120 kg/m

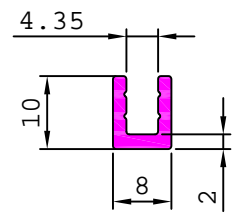

17674

0.306 kg/m

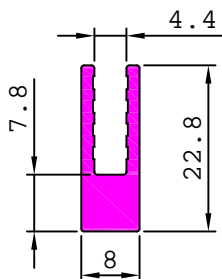

17687

0.223 kg/m

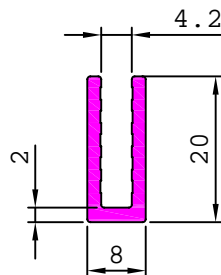

24836

0.219 kg/m

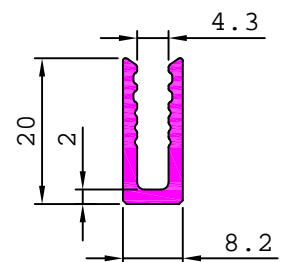

TEXTILE MACHINERY

24817 0.108 kg/m

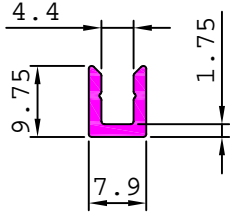

24818 0.186 kg/m

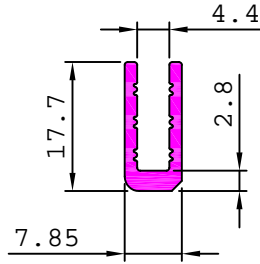

24826 0.144 kg/m

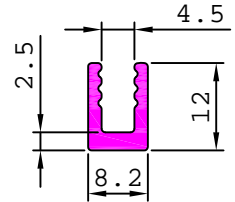

24897 0.209 kg/m

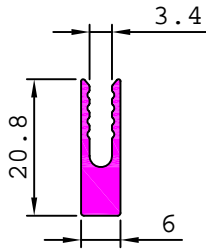

24898 0.300 kg/m

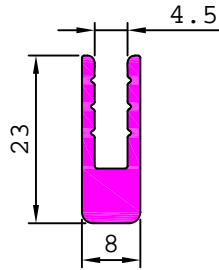

40521 0.264 kg/m

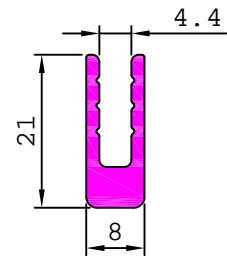

S5615 0.279 kg/m

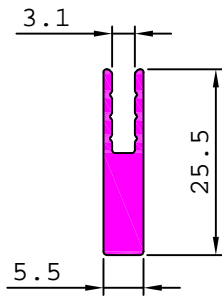



TEXTILE MACHINERY

24877 0.613 kg/m

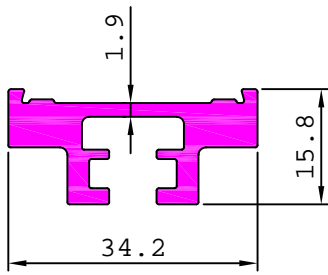

24816 1.042 kg/m

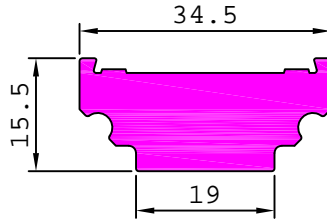

24751 0.891 kg/m

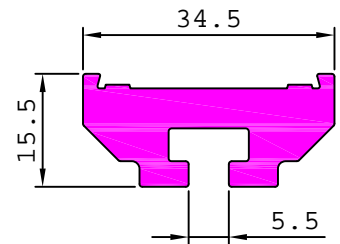

24855 0.713 kg/m

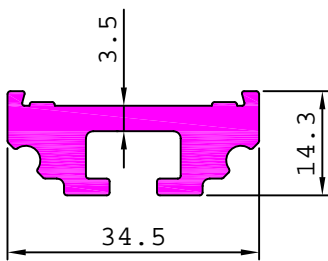

24856 0.848 kg/m

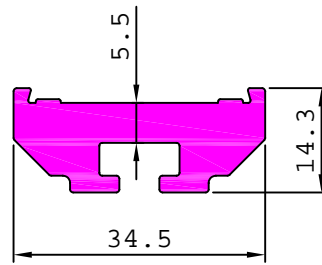

24883 0.991 kg/m

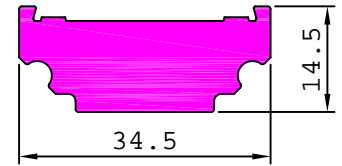

40506 0.600 kg/m

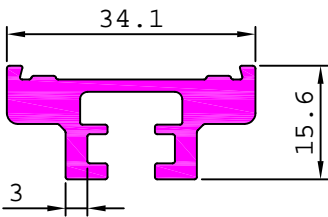

24743 0.754 kg/m

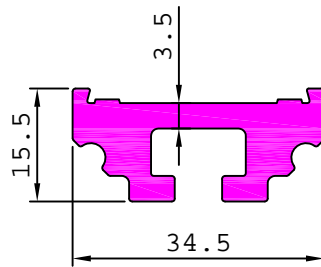

40525 0.785 kg/m

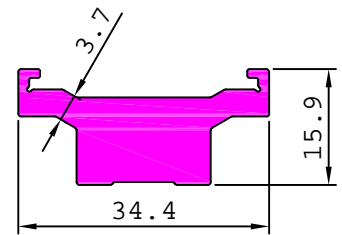

40517 0.797 kg/m

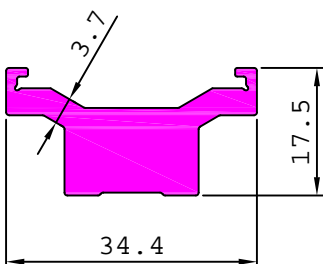

24741 0.547 kg/m

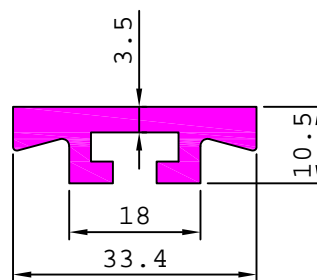

24755 0.255 kg/m

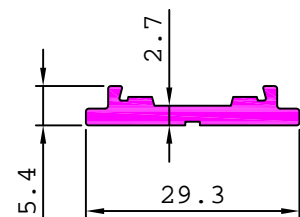

TEXTILE MACHINERY

24887 0.608 kg/m

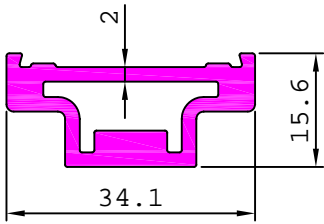

24771 0.226 kg/m

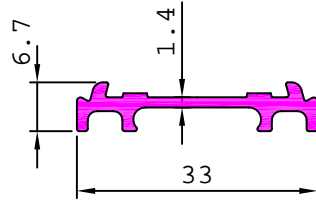

24775 0.259 kg/m

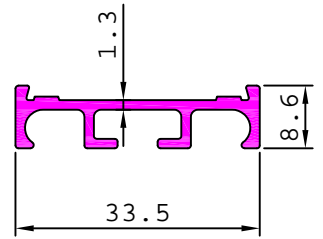

24780 0.453 kg/m

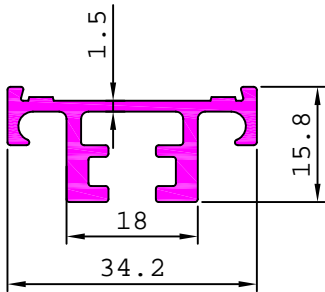

24793 0.303 kg/m

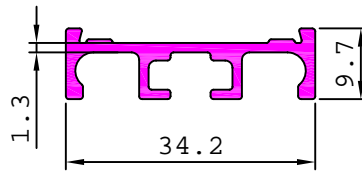

24804 0.807 kg/m

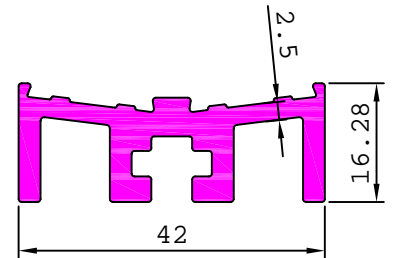

24814 0.556 kg/m

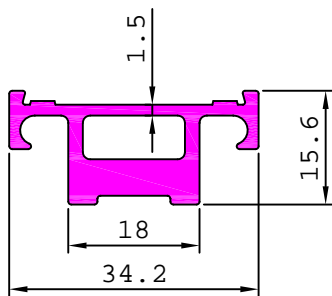

24815 0.231 kg/m

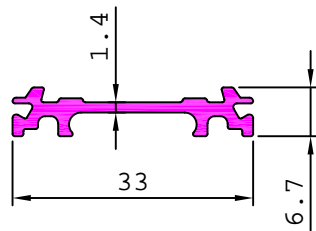

24810 0.245 kg/m

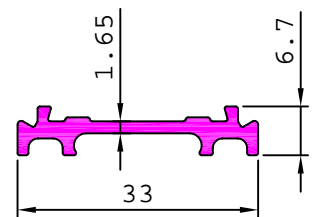

24821 0.326 kg/m

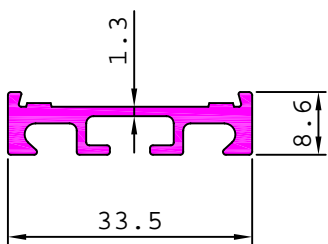

24822 0.394 kg/m

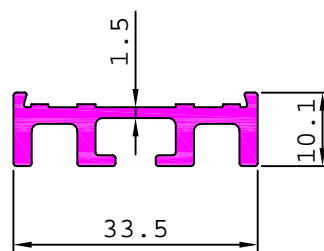

24827 0.379 kg/m

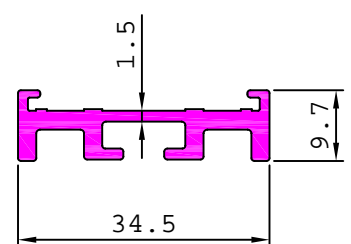

TEXTILE MACHINERY

40523 0.601 kg/m

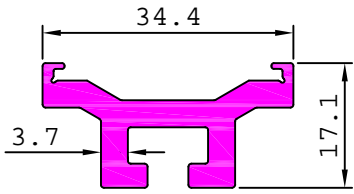

24900 0.589 kg/m

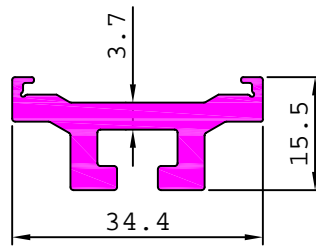

24863 0.502 kg/m

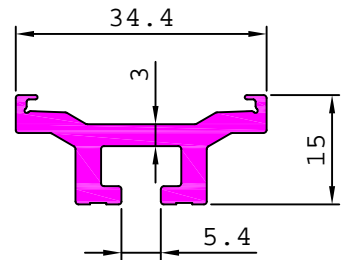

24854 0.426 kg/m

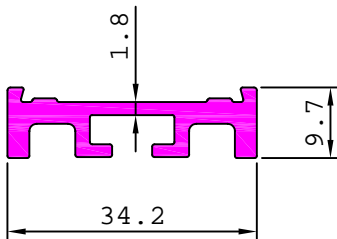

40504 0.151 kg/m

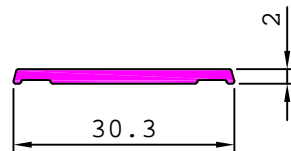

24853 0.610 kg/m

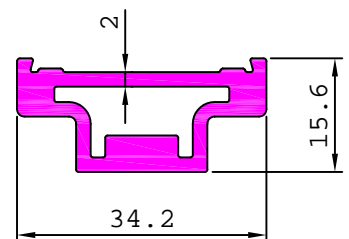

24868 0.252 kg/m

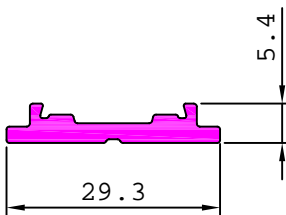

24837 0.152 kg/m

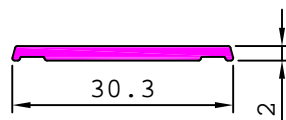

24838 0.119 kg/m

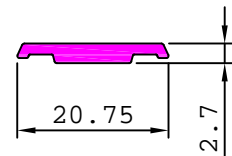

24839 0.124 kg/m

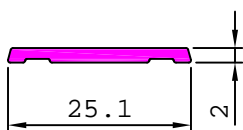

24842 0.085 kg/m

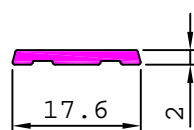

24847 0.250 kg/m

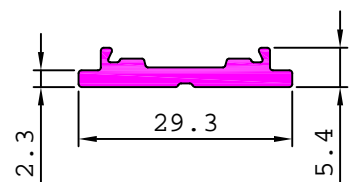

TEXTILE MACHINERY

24882 0.380 kg/m

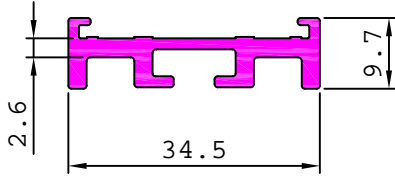

24896 0.370 kg/m

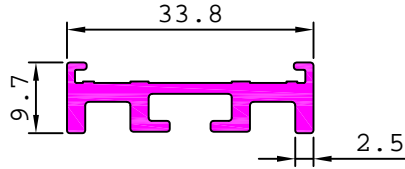

40503 0.435 kg/m

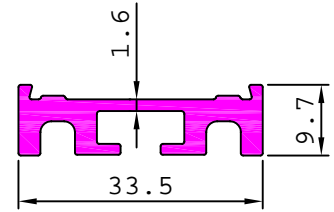

40507 0.450 kg/m

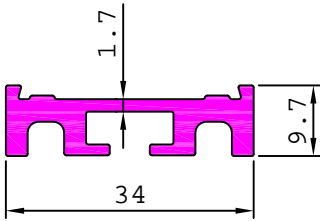

24892 0.436 kg/m

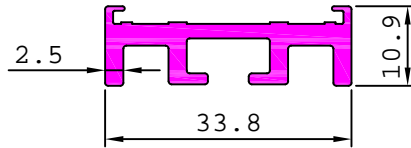

40526 0.405 kg/m

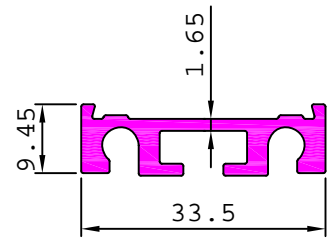

TEXTILE MACHINERY

24832

3.799 kg/m

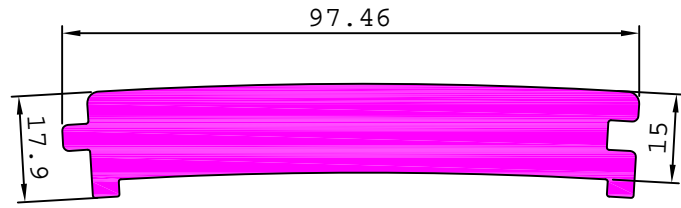

24850

3.242 kg/m

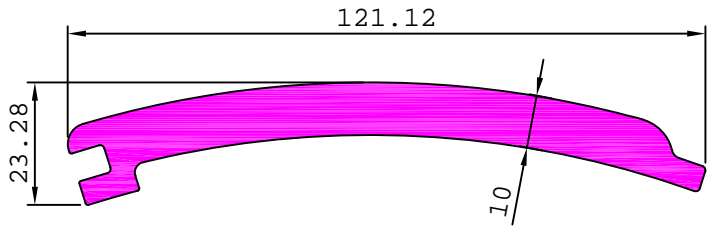

24858

1.847 kg/m

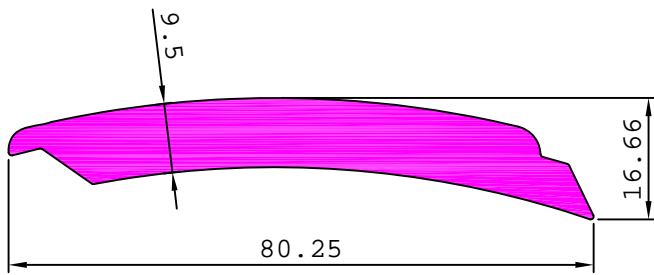

24859

1.908 kg/m

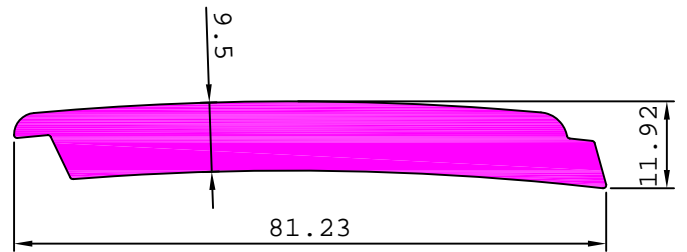

24857

2.354 kg/m

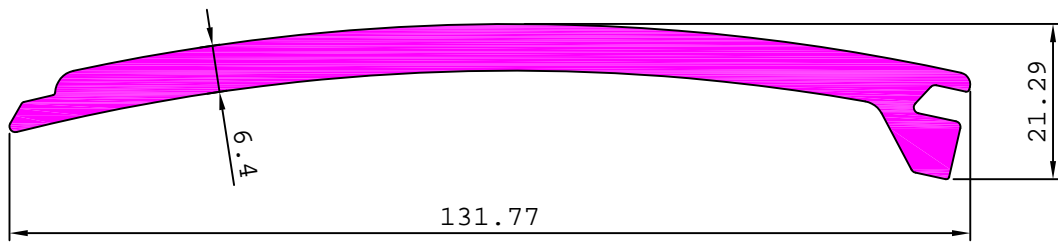

24866

0.933 kg/m

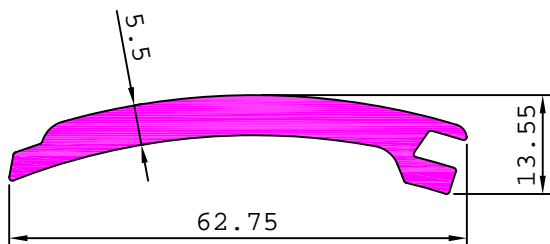

24873

2.167 kg/m

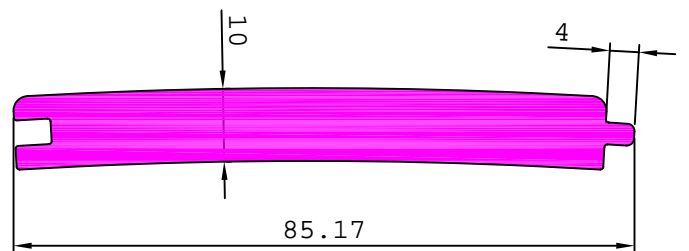

TEXTILE MACHINERY

27989

2.204 kg/m

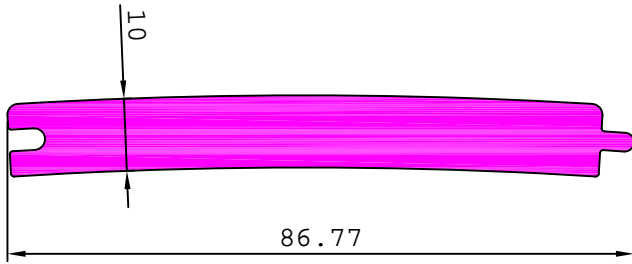

24865

2.448 kg/m

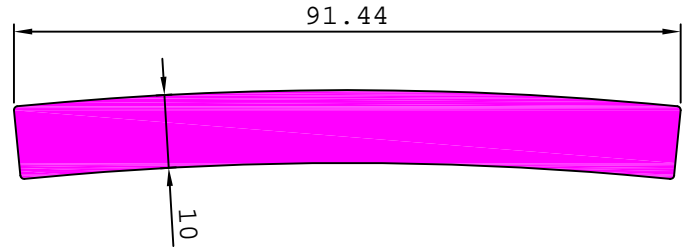

24852

2.248 kg/m

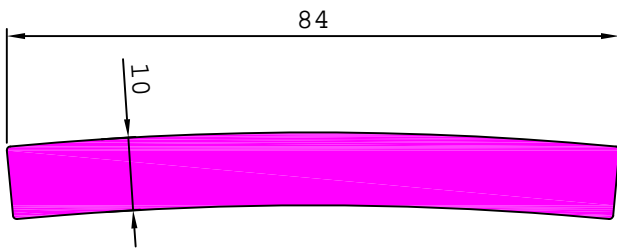

24869

1.390 kg/m

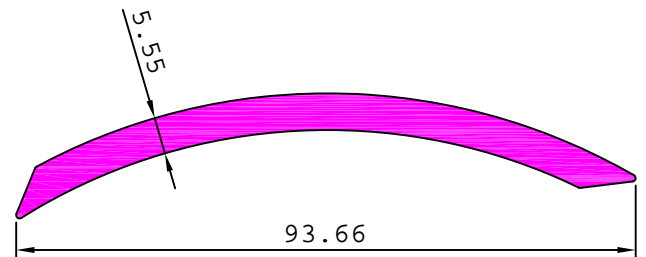

24871

1.764 kg/m

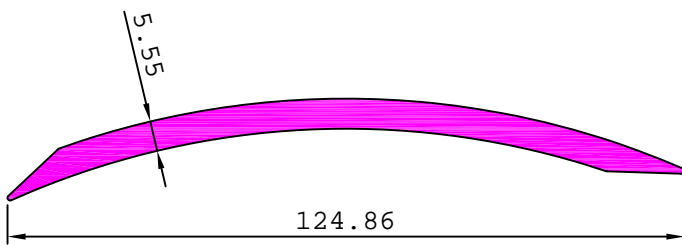

24872

1.769 kg/m

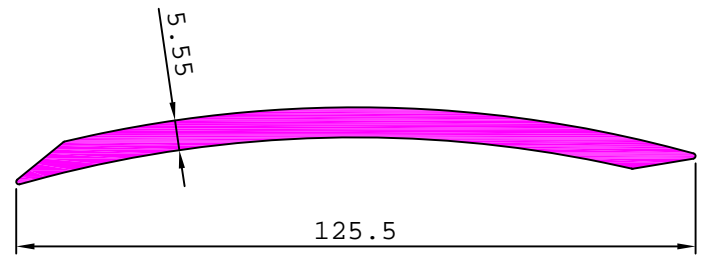

24875

2.382 kg/m

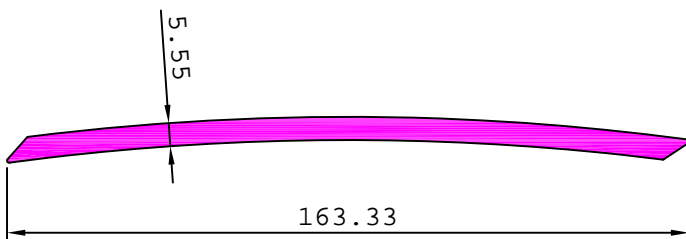

24849

2.290 kg/m

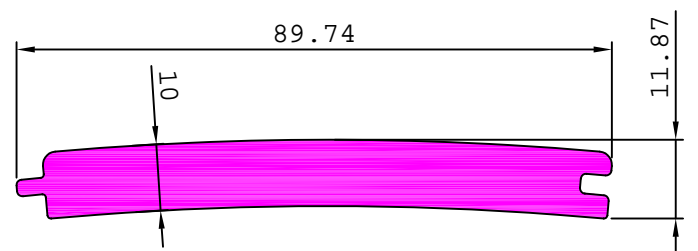

TEXTILE MACHINERY

27975

3.317 kg/m

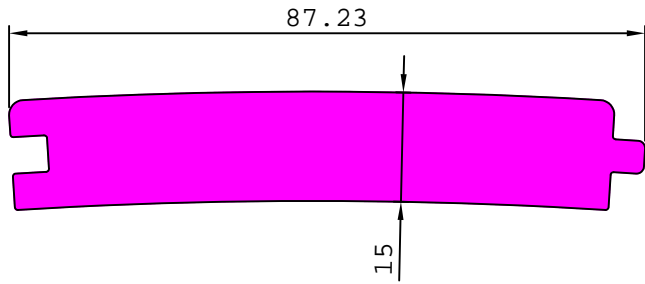

24886

3.390 kg/m

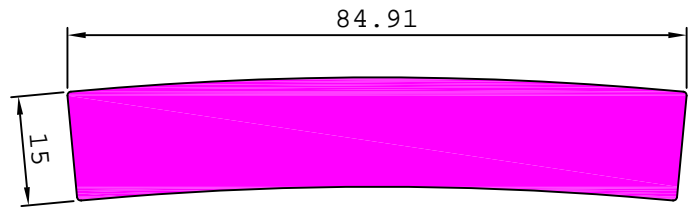

24899

2.163 kg/m

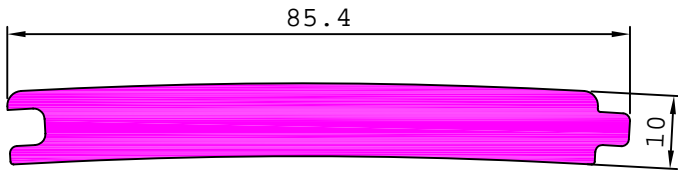

40502

3.526 kg/m

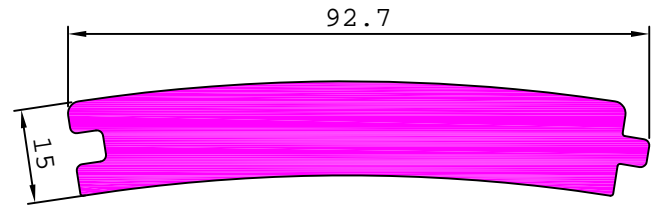

40501

3.882 kg/m

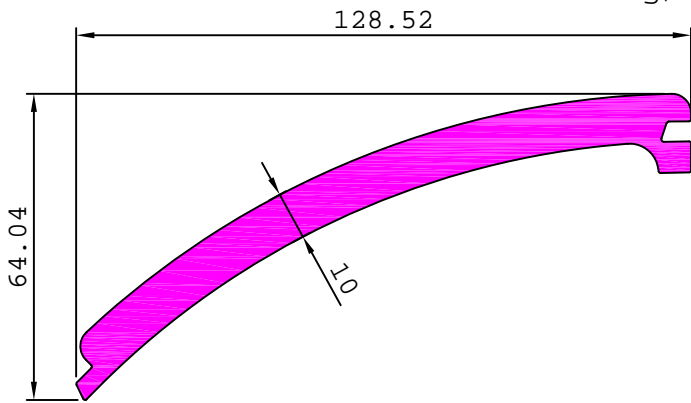

40511

3.077 kg/m

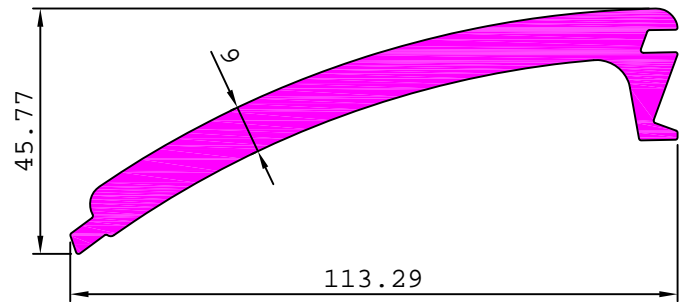

40514

2.207 kg/m

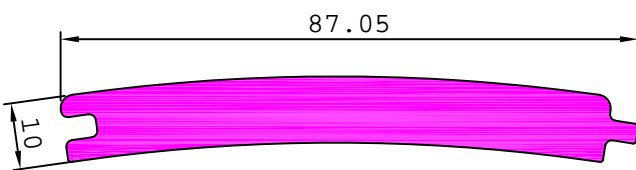

40518

5.893 kg/m

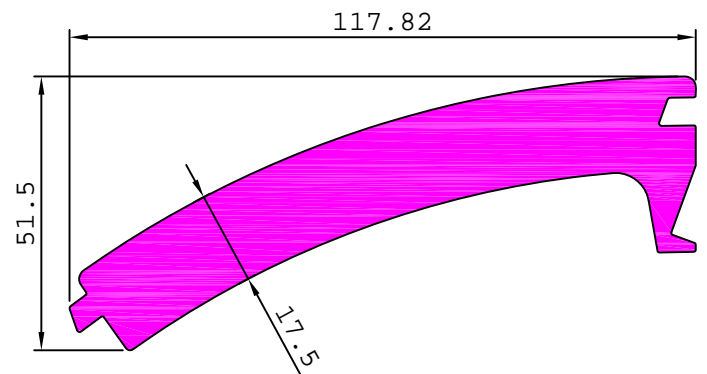

TEXTILE MACHINERY

24888

3.471 kg/m

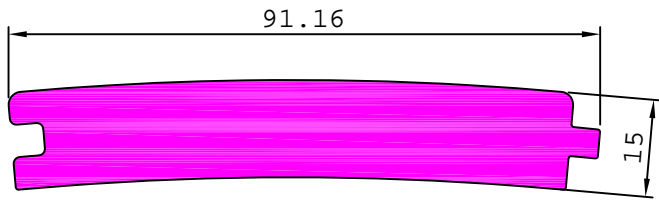

24894

3.519 kg/m

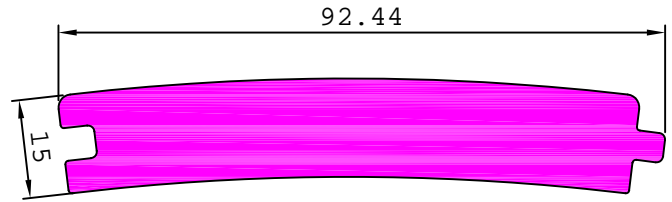

28109

2.314 kg/m

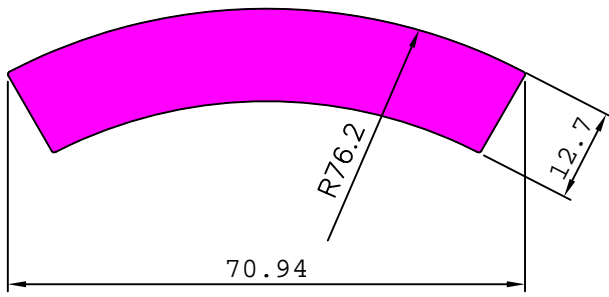

40519

4.075 kg/m

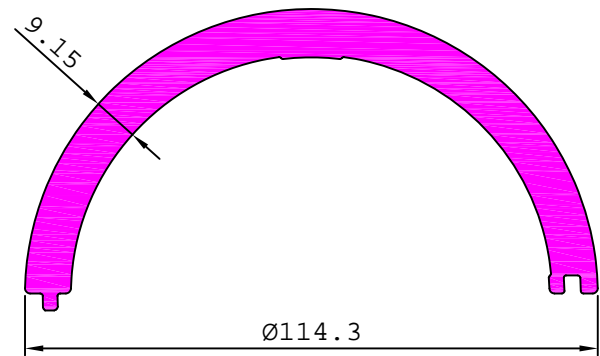

28372

0.182 kg/m

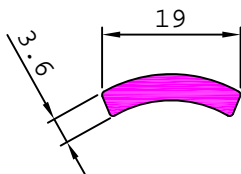

TEXTILE MACHINERY

24825

1.279 kg/m

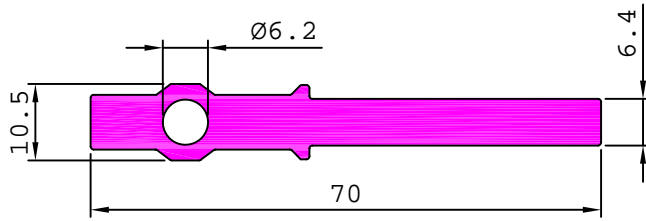

24840

1.172 kg/m

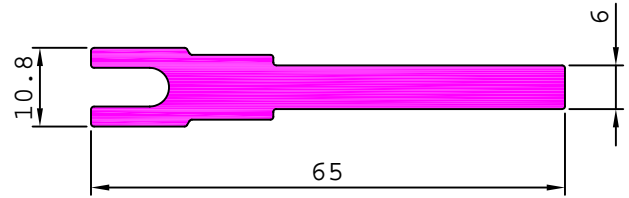

24841

1.427 kg/m

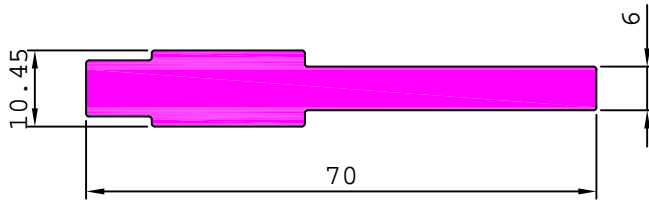

24846

1.129 kg/m

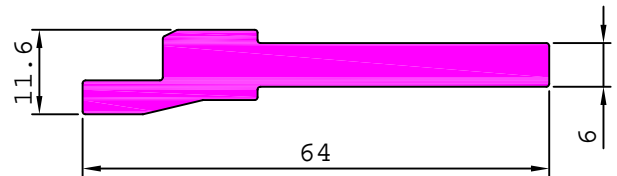

24876

1.046 kg/m

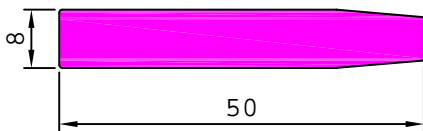

24861

0.897 kg/m

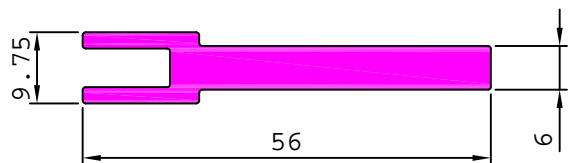

24862

0.939 kg/m

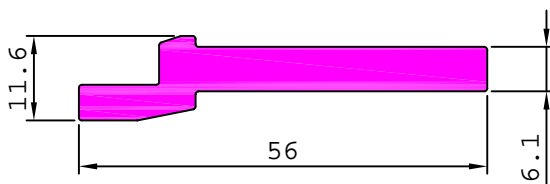

24880

1.626 kg/m

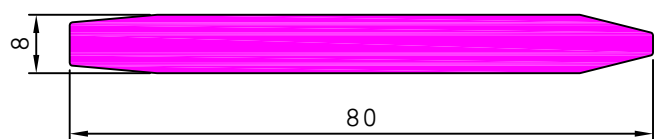

TEXTILE MACHINERY

40508

0.978 kg/m

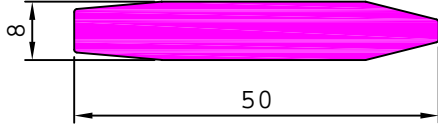

40513

1.009 kg/m

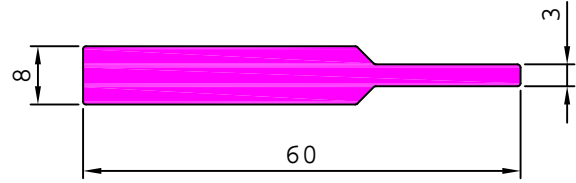

40531

0.819 kg/m

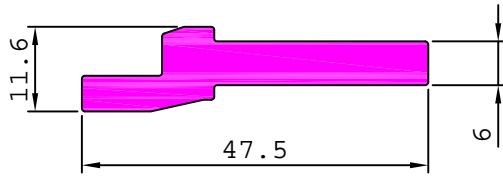

40510

2.160 kg/m

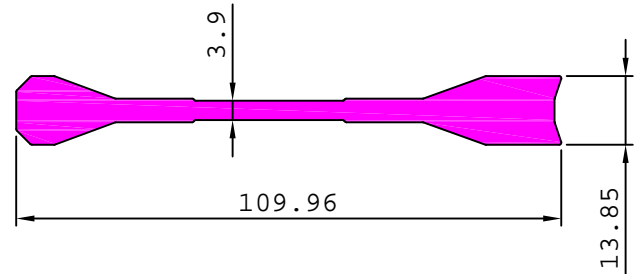

29673

1.722 kg/m

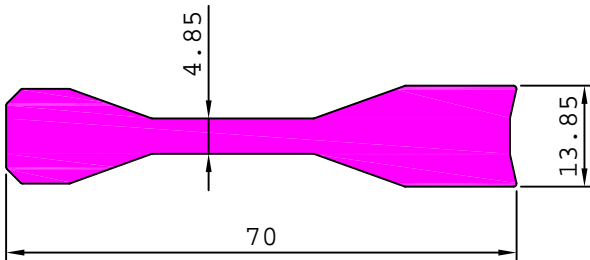

TEXTILE MACHINERY

24796

1.015 kg/m

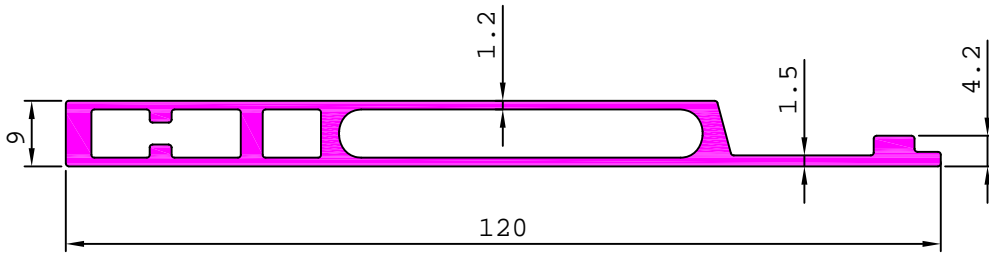

24797

0.981 kg/m

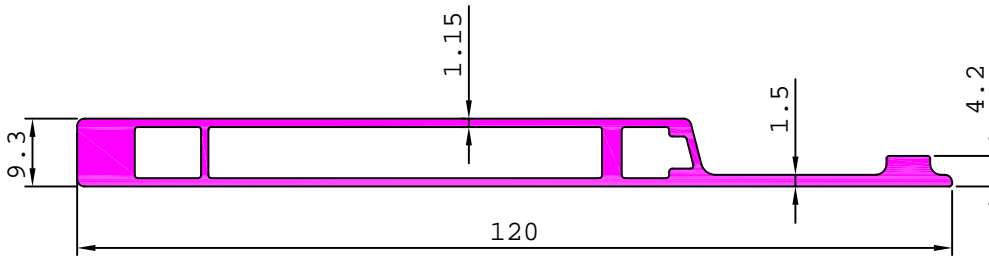

24802

0.908 kg/m

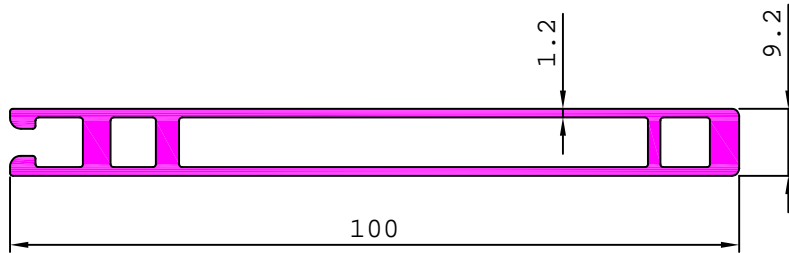

24848

0.855 kg/m

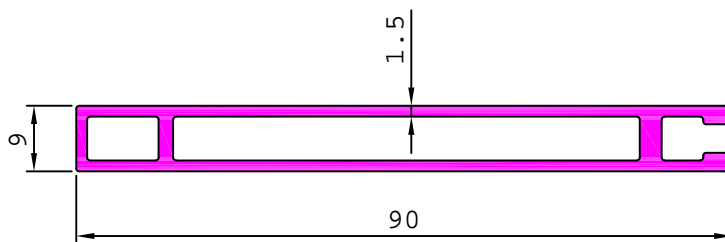

TEXTILE MACHINERY

24807

1.217 kg/m

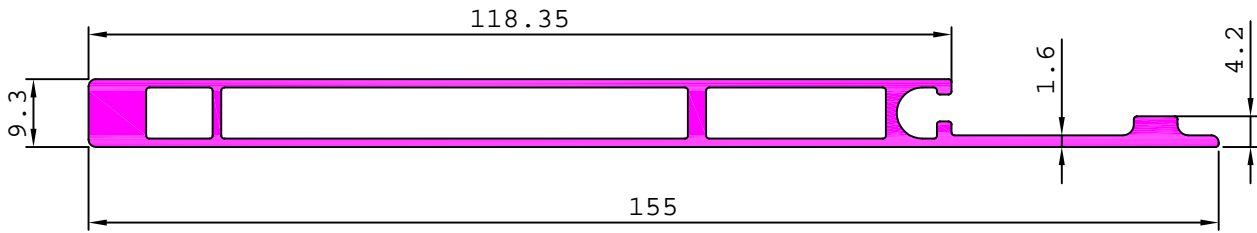

24808

1.017 kg/m

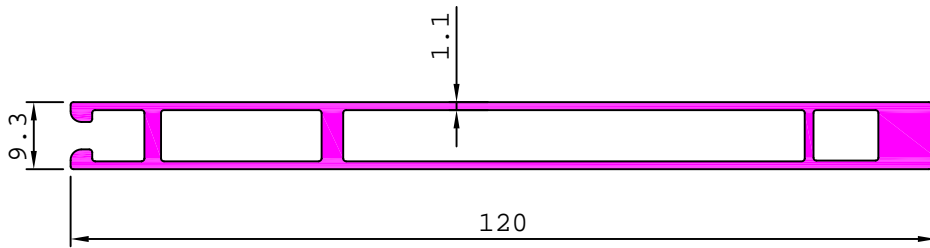

24812

1.038 kg/m

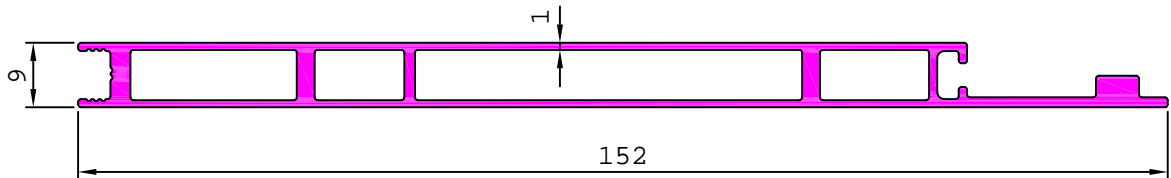

24819

1.280 kg/m

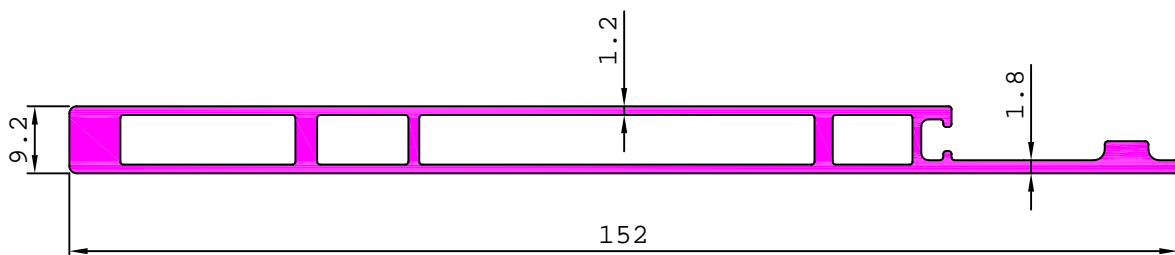

TEXTILE MACHINERY

24851

1.190 kg/m

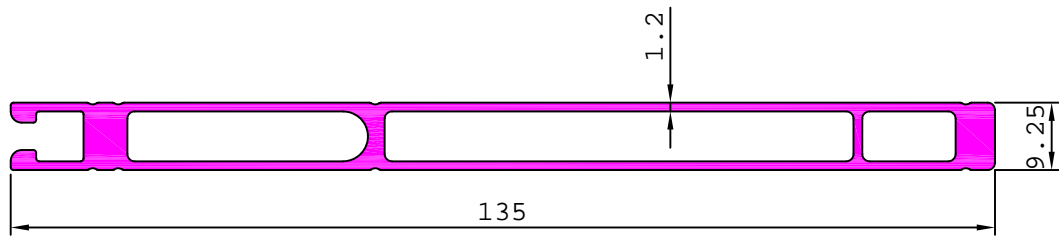

24831

0.838 kg/m

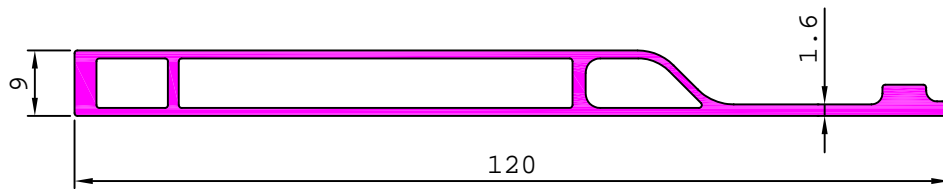

24878

0.949 kg/m

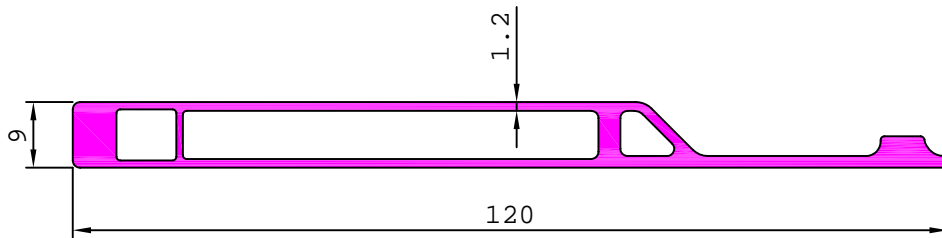

24864

1.067 kg/m

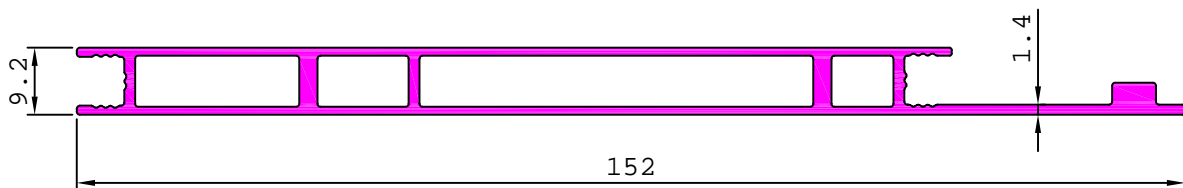

TEXTILE MACHINERY

24895

0.862 kg/m

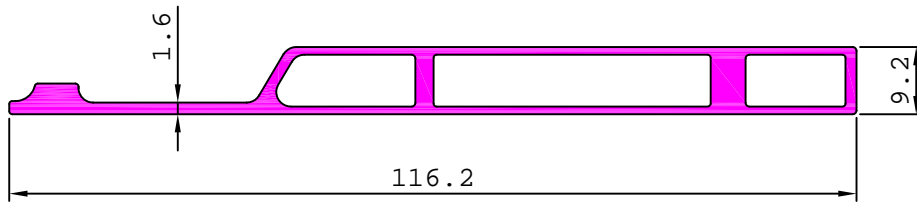

24890

1.101 kg/m

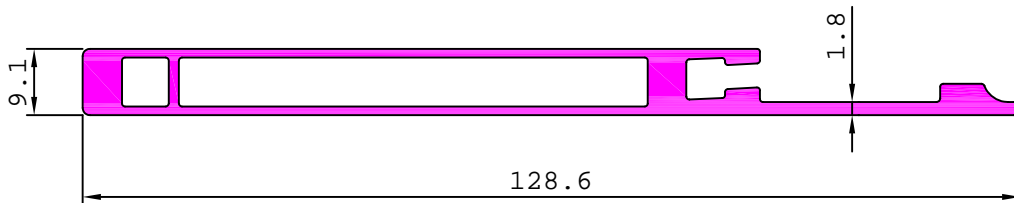

24893

0.924 kg/m

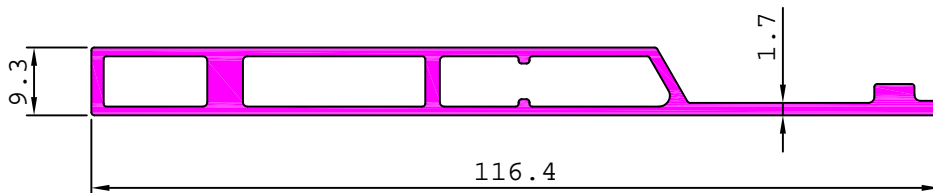

S5564

0.922 kg/m

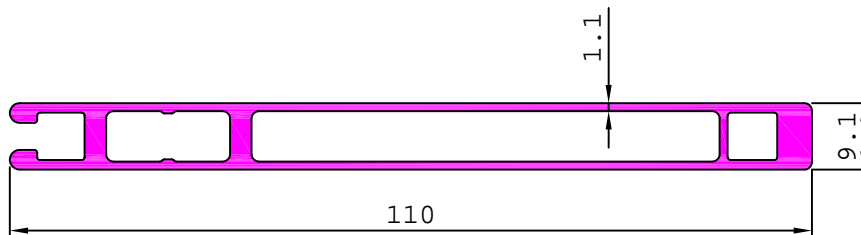

TEXTILE MACHINERY

40505

0.811 kg/m

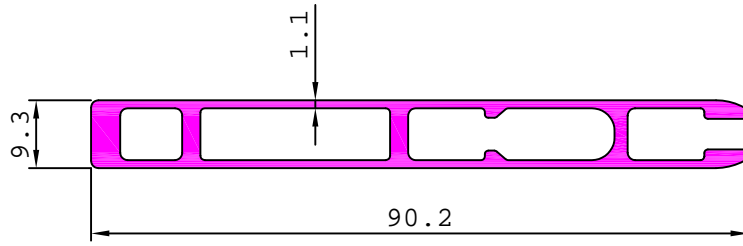

40509

0.888 kg/m

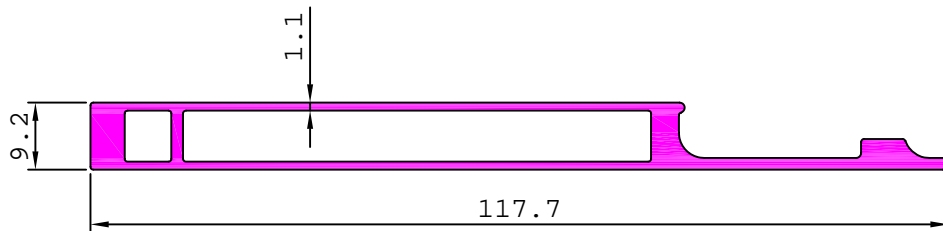

27359

0.830 kg/m

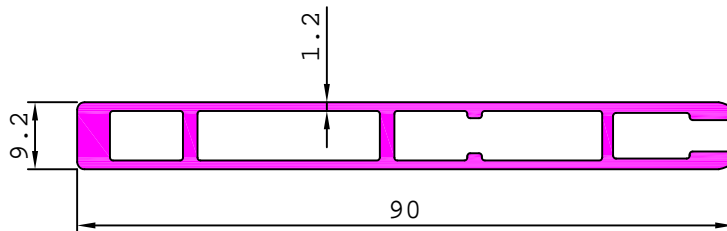

27622

0.946 kg/m

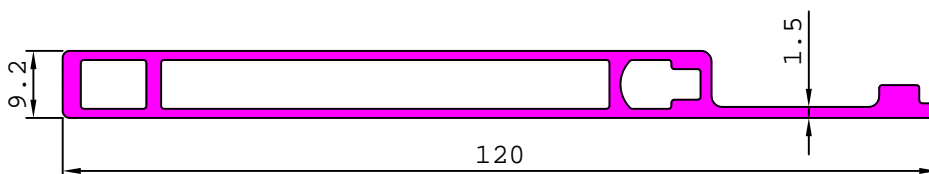



TEXTILE MACHINERY

27665

0.780 kg/m

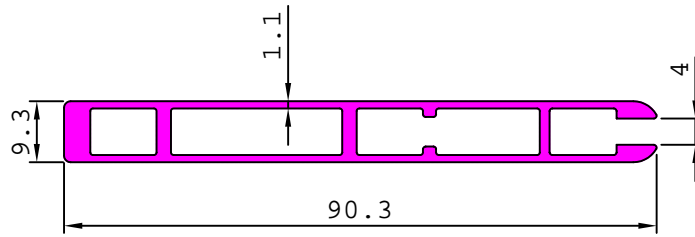

TEXTILE MACHINERY

24776

10.430 kg/m

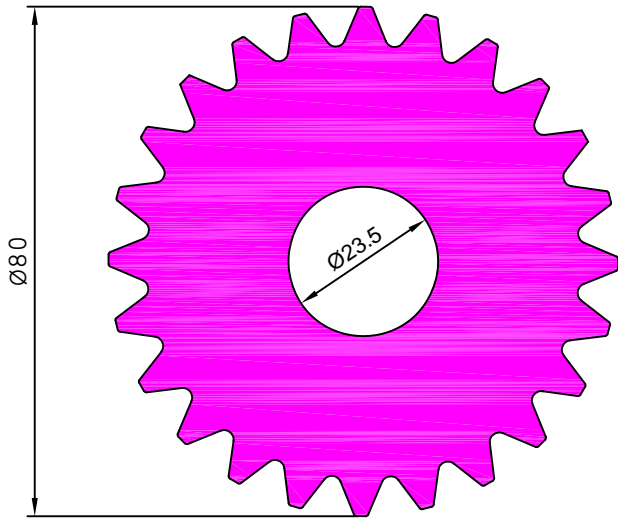

24768

11.712 kg/m

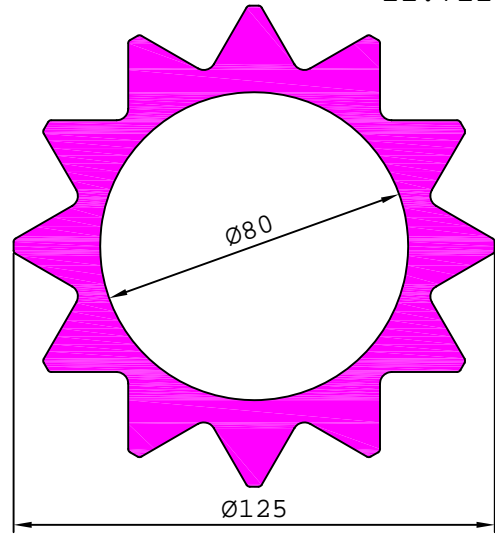

24824

6.306 kg/m

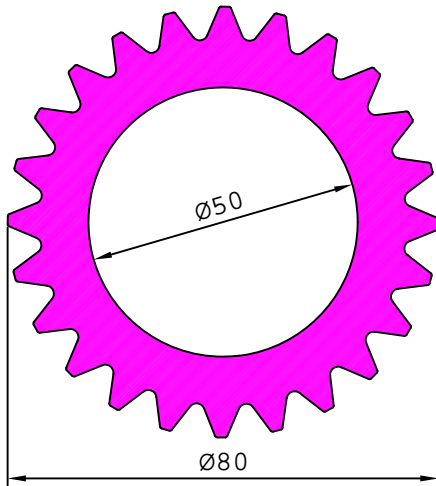

24763

8.057 kg/m

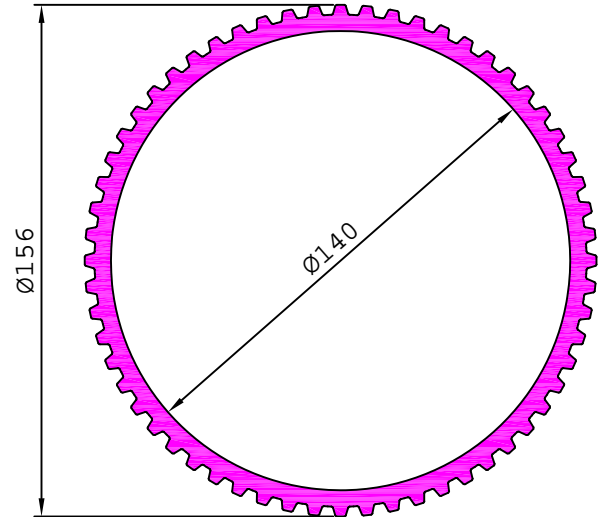

24764

7.803 kg/m

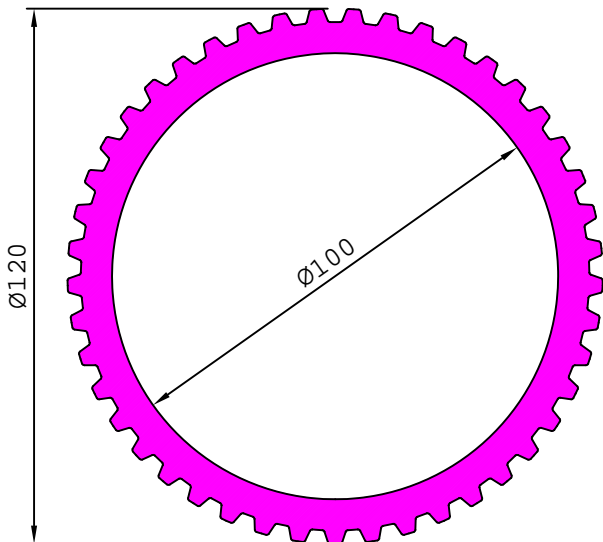

24762

1.479 kg/m

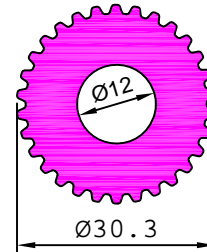

40516

0.290 kg/m

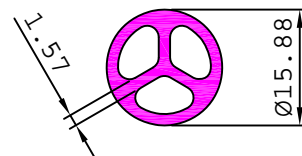

TEXTILE MACHINERY

24874

11.527 kg/m

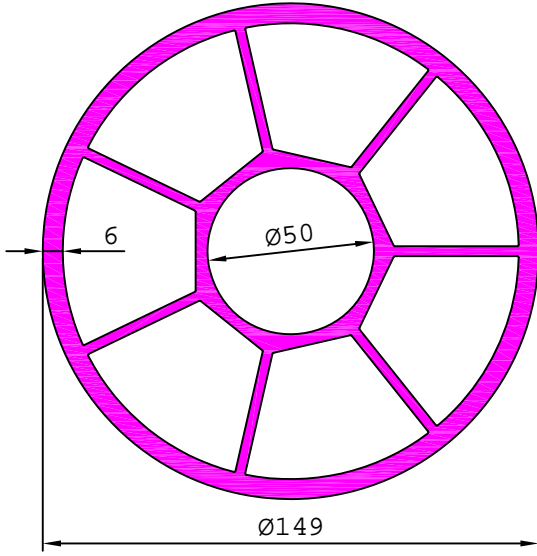

24885

3.728 kg/m

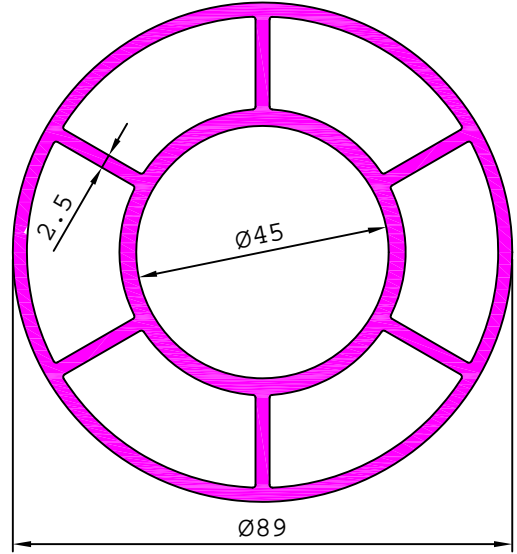

40512

9.575 kg/m

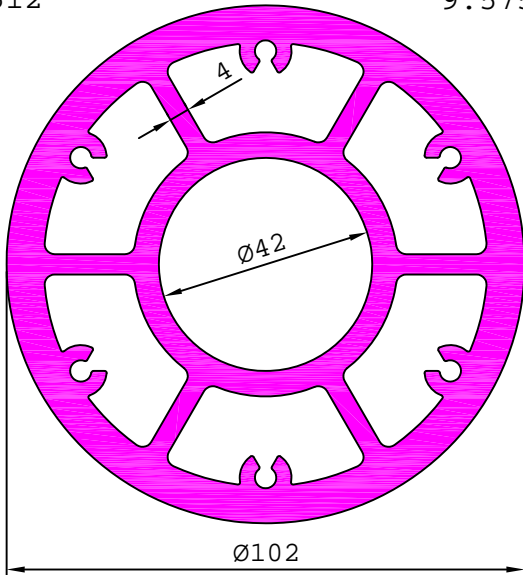

S4981

12.709 kg/m

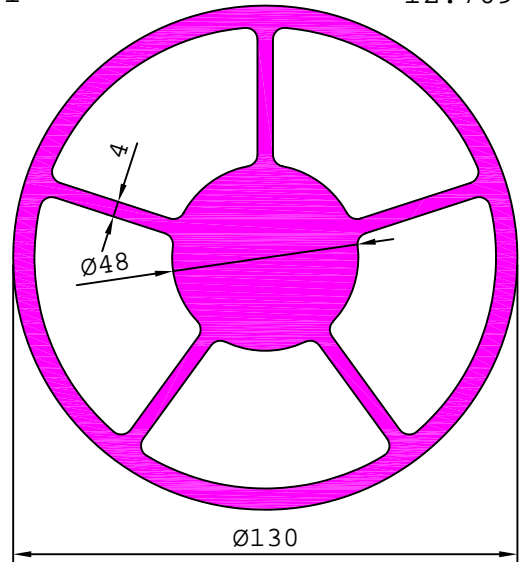

S4982

5.675 kg/m

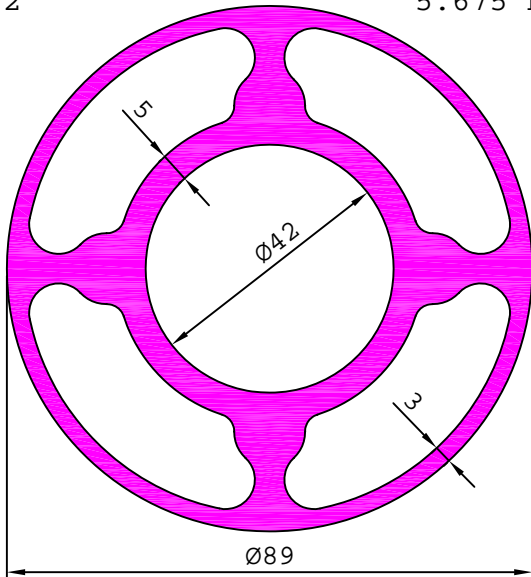

24809

2.332 kg/m

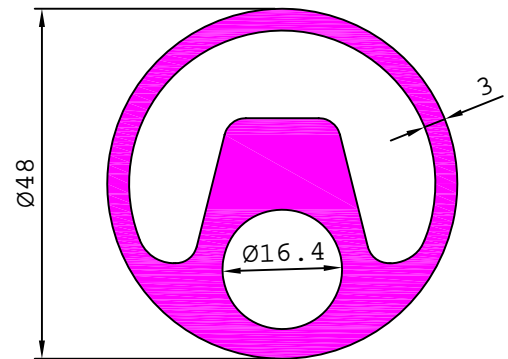



TEXTILE MACHINERY

28448

9.868 kg/m

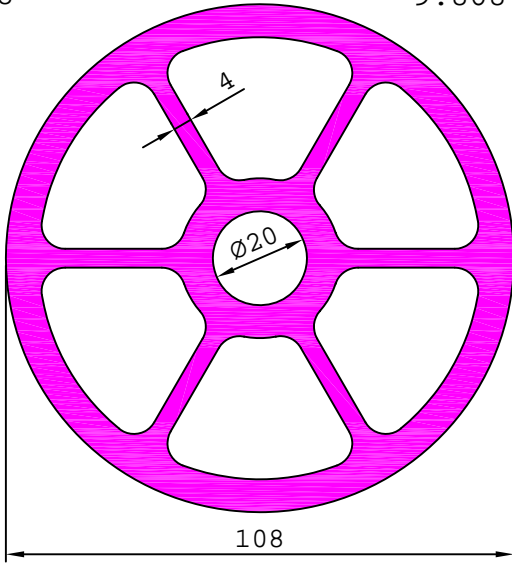

28449

27.715 kg/m

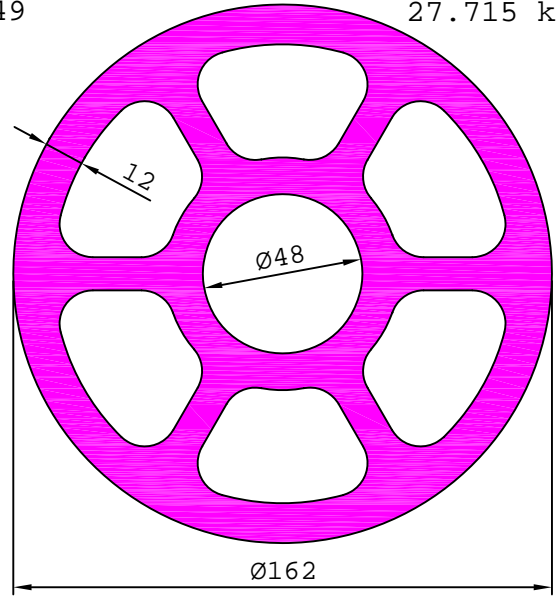

TEXTILE MACHINERY

24820

2.692 kg/m

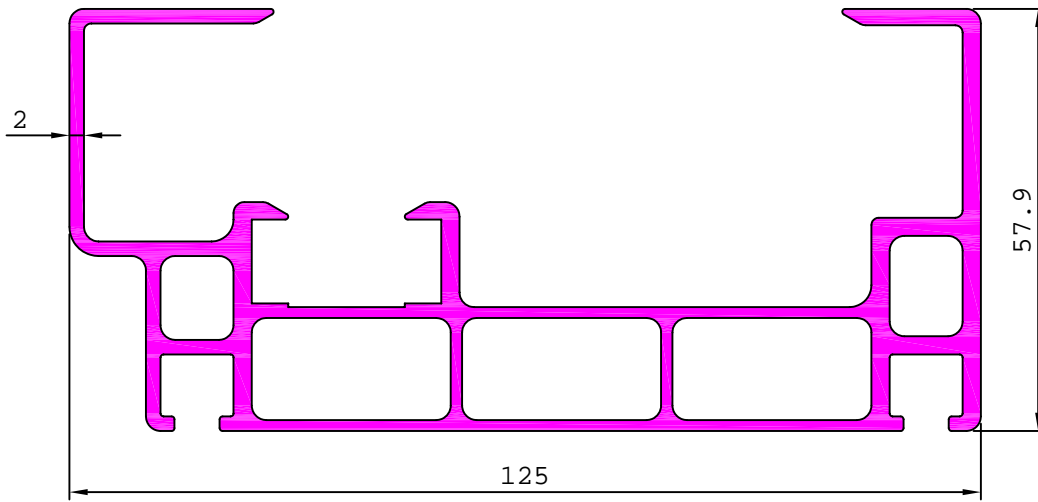

24829

2.691 kg/m

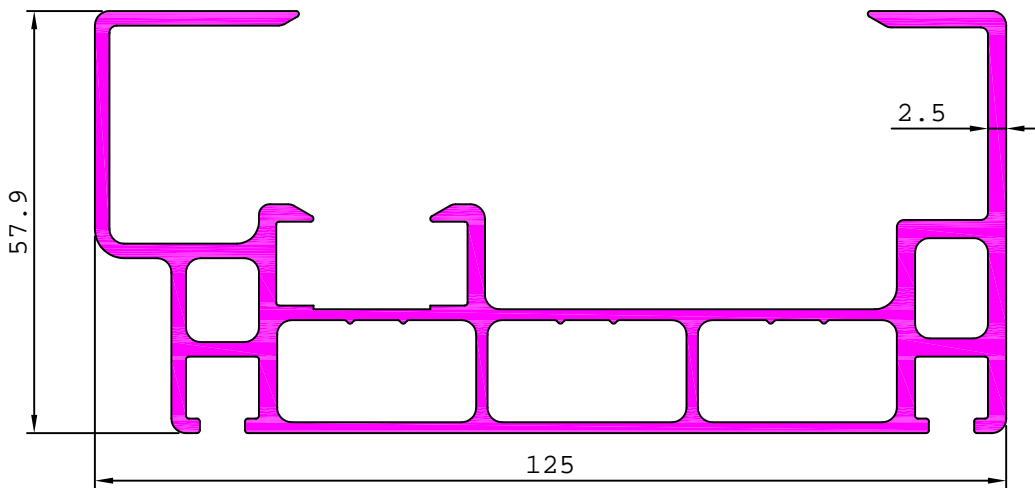

S5699

4.080 kg/m

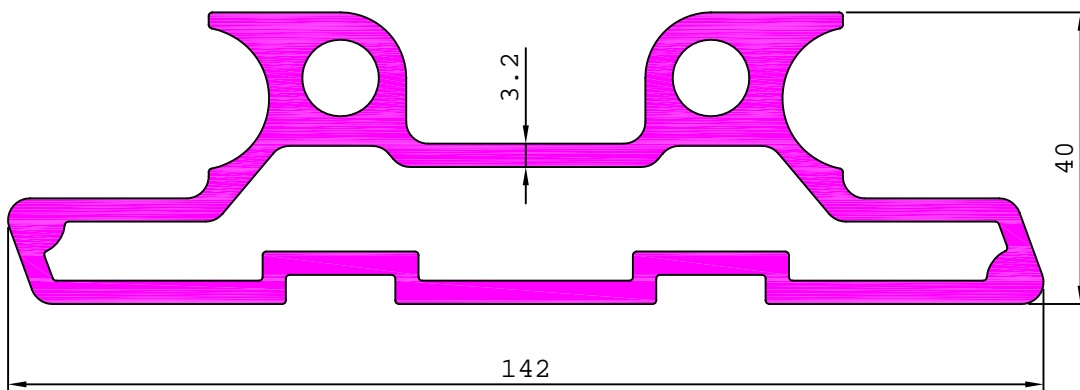

TEXTILE MACHINERY

24798

2.722 kg/m

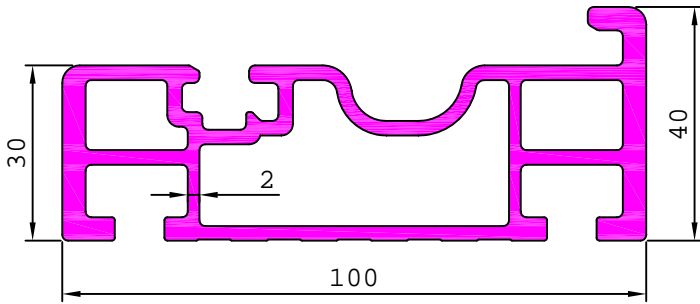

24835

3.063 kg/m

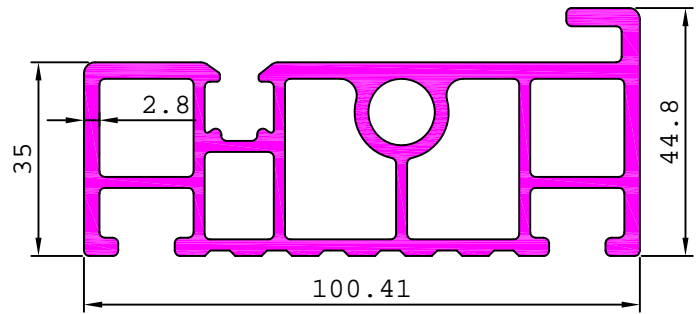

24791

4.106 kg/m

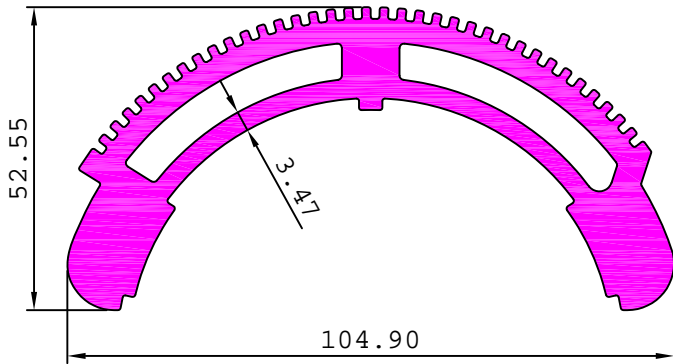

24795

3.695 kg/m

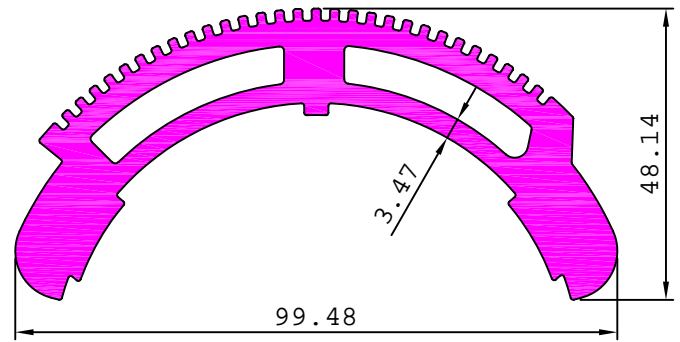

24834

0.822 kg/m

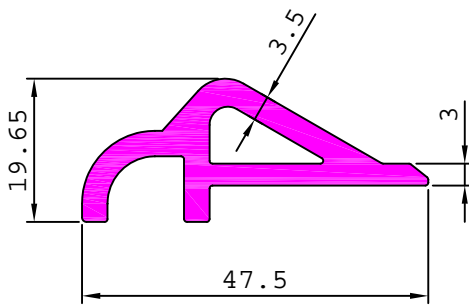

S5571

0.804 kg/m

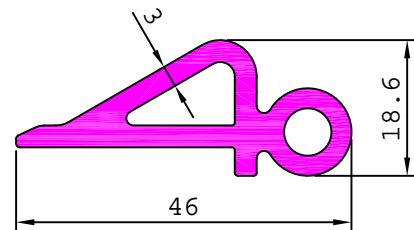

24879

1.200 kg/m

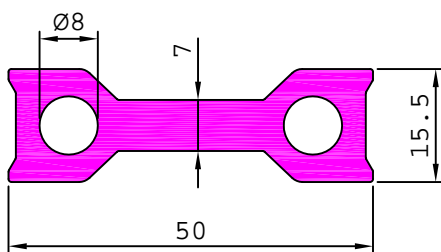

40520

1.221 kg/m

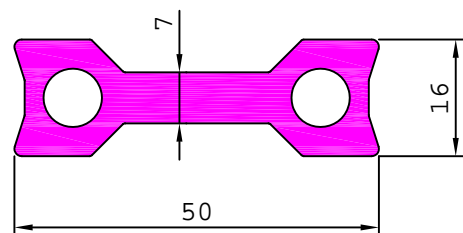

TEXTILE MACHINERY

40522

0.441 kg/m

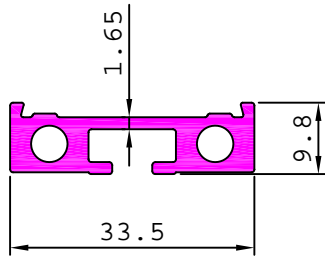

24830

0.431 kg/m

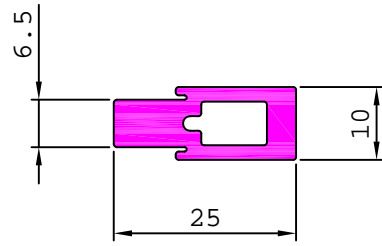

24759

0.609 kg/m

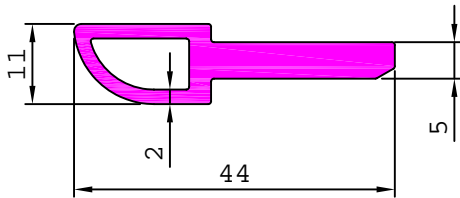

24790

0.538 kg/m

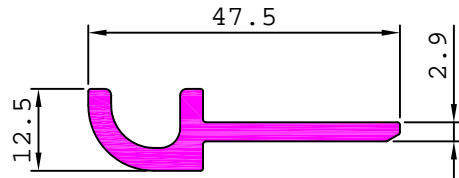

24715

0.192 kg/m

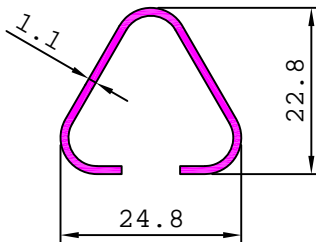

S5797

0.159 kg/m

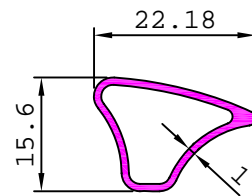

36103

0.168 kg/m

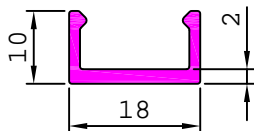

24786

1.357 kg/m

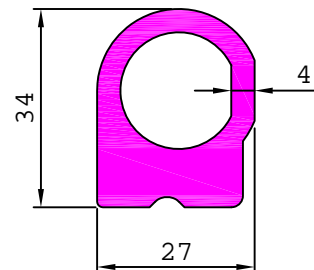

36104

0.082 kg/m

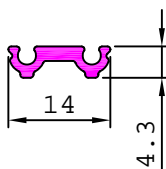



TEXTILE MACHINERY

40527

0.396 kg/m

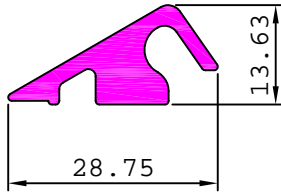



TEXTILE MACHINERY

24788

1.907 kg/m

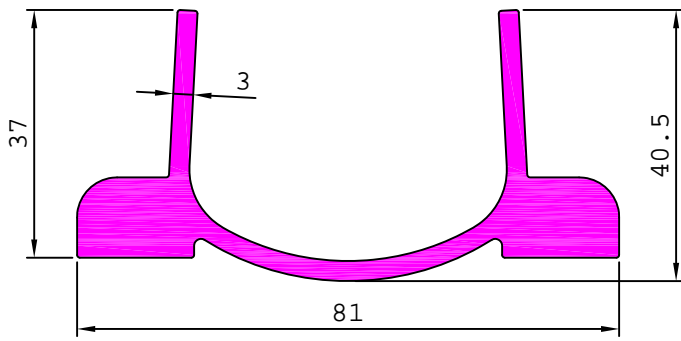

24833

2.099 kg/m

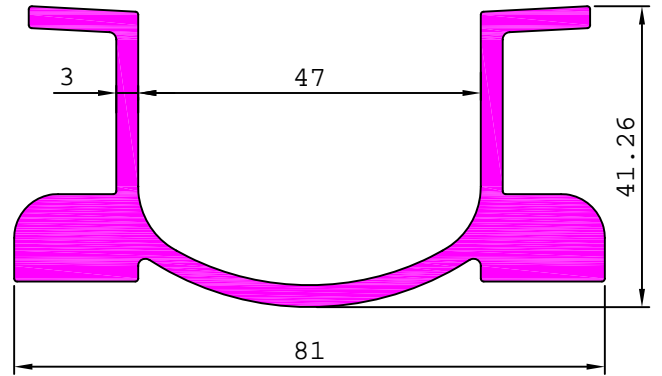

24845

3.574 kg/m

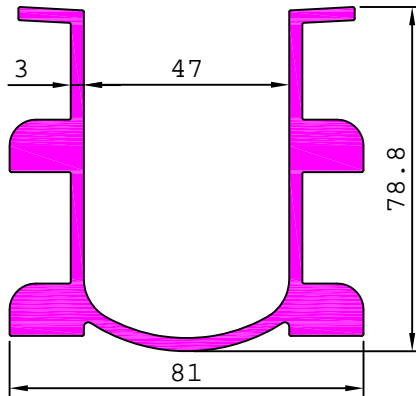

TEXTILE MACHINERY

24745

1.986 kg/m

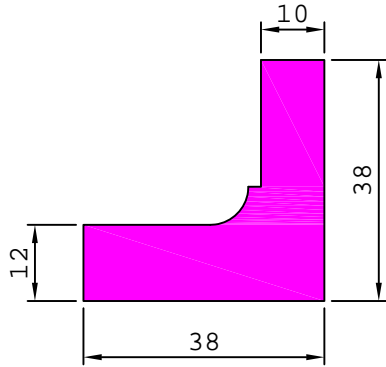

24777

2.800 kg/m

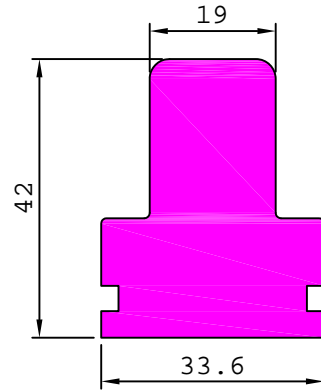

24781

2.132 kg/m

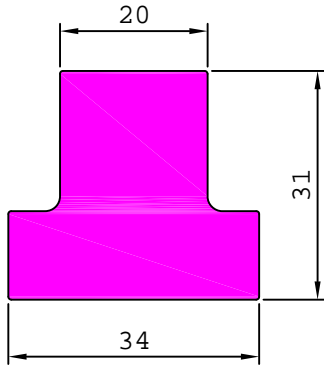

24739

1.224 kg/m

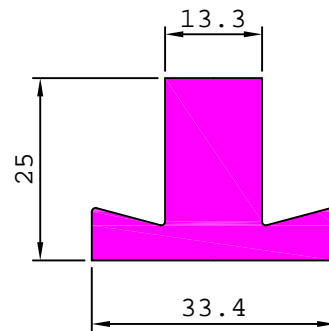

24737

2.434 kg/m

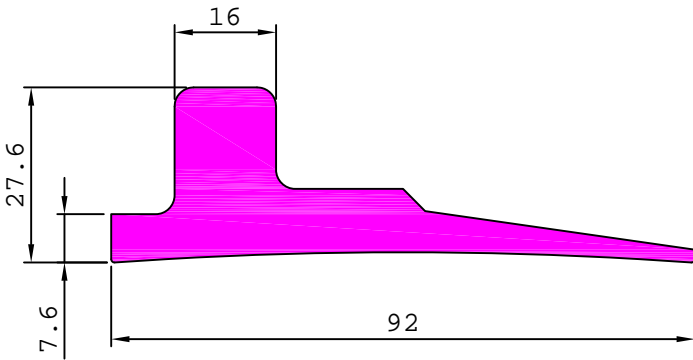

40530

1.771 kg/m

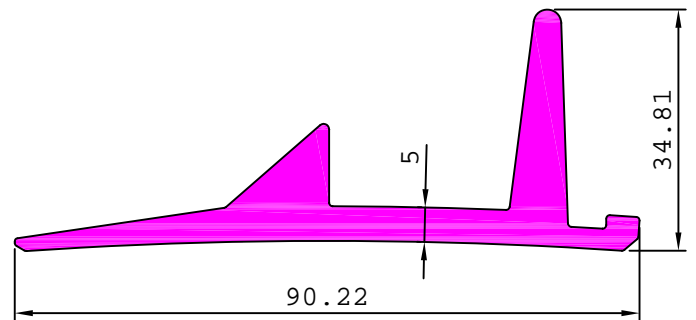

S5380

2.800 kg/m

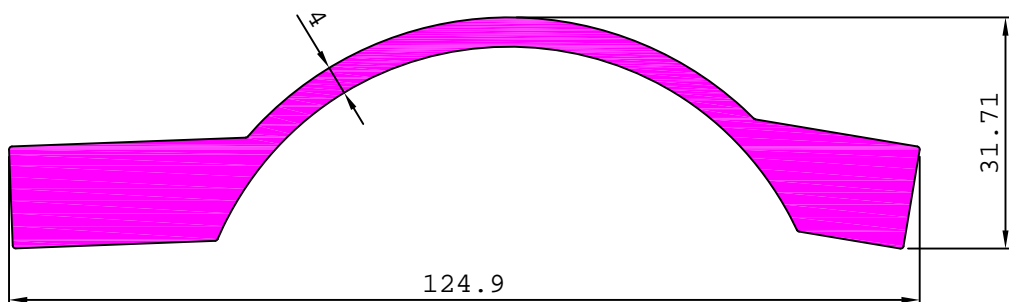

TEXTILE MACHINERY

24746

0.724 kg/m

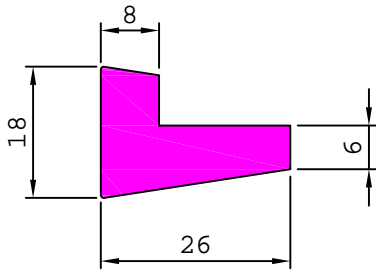

24740

5.797 kg/m

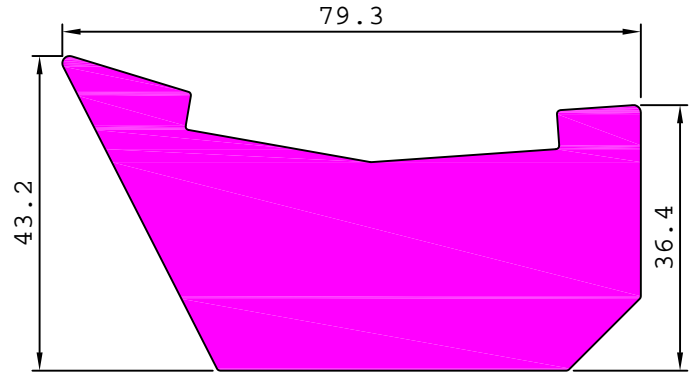

24769

12.824 kg/m

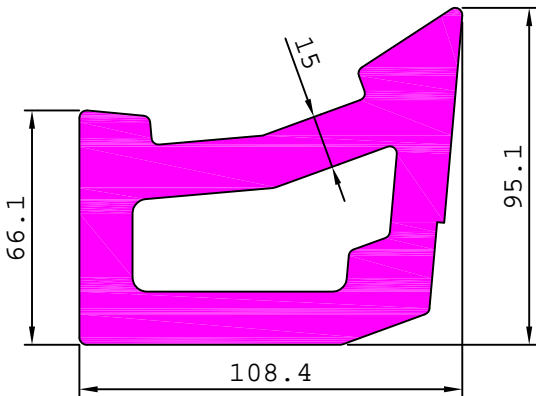

24867

4.094 kg/m

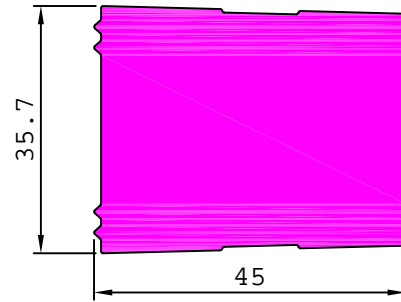

24889

0.592 kg/m

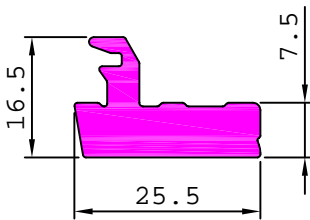

24860

0.206 kg/m

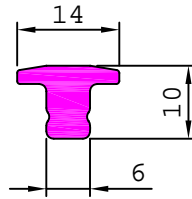

24734

0.534 kg/m

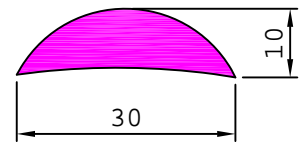

S6011

0.409 kg/m

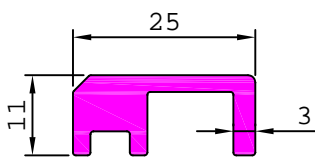

24884

0.560 kg/m

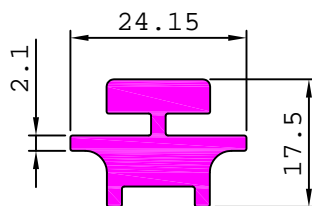

24736

0.772 kg/m

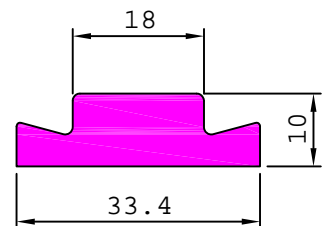

TEXTILE MACHINERY

24770

9.505 kg/m

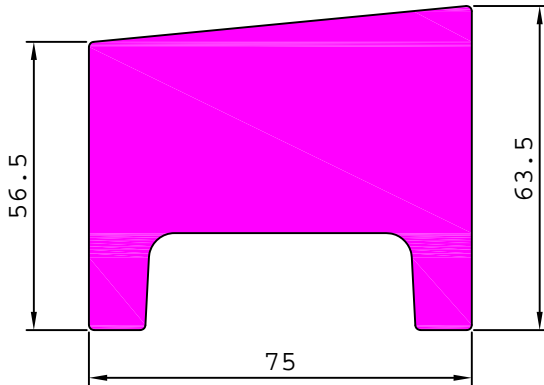

24799

5.042 kg/m

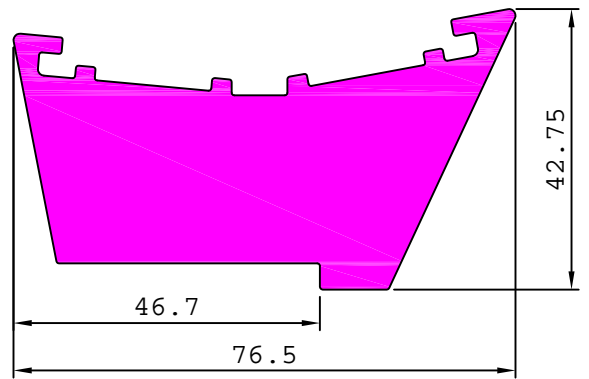

24774

5.946 kg/m

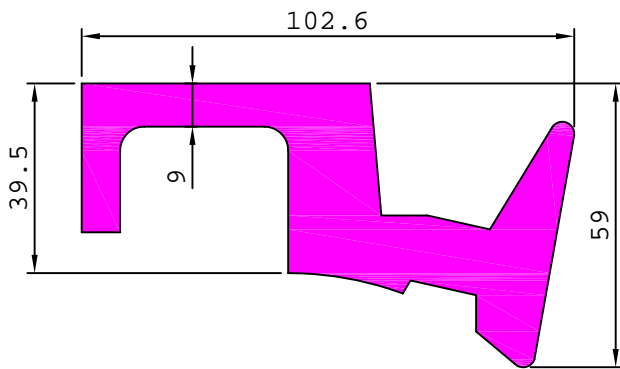

24787

2.143 kg/m

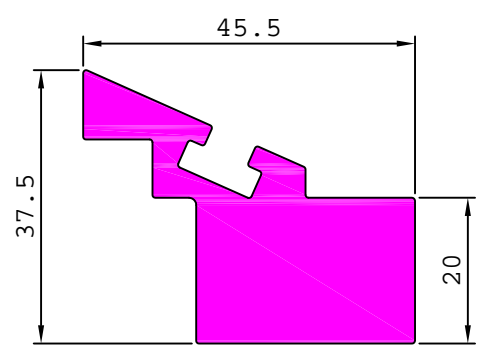

24844

2.743 kg/m

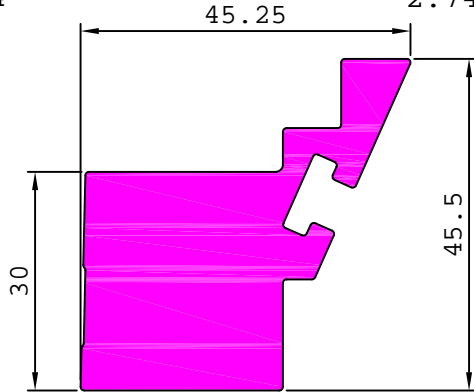

28253

2.711 kg/m

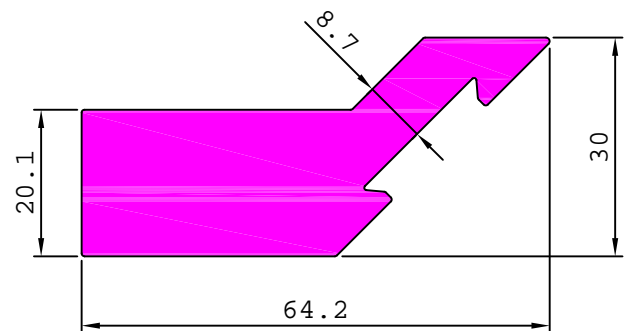

24828

5.523 kg/m

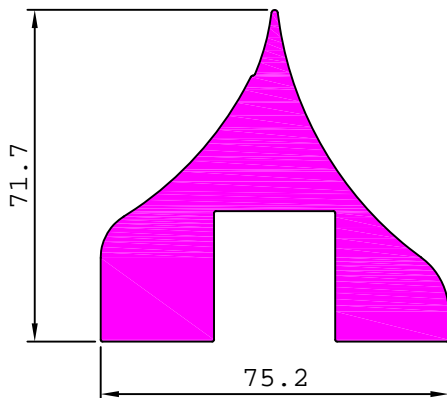

24891

3.535 kg/m

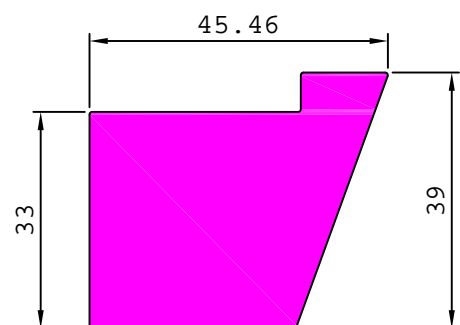

TEXTILE MACHINERY

24823

4.265 kg/m

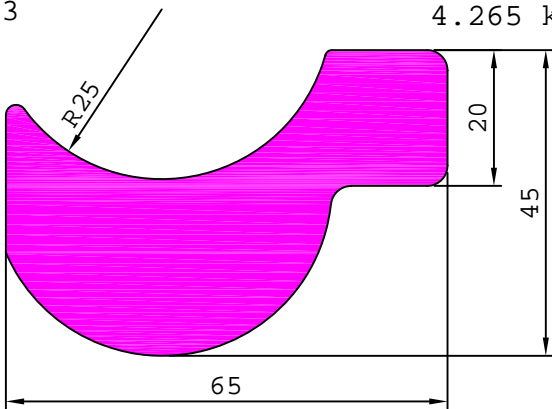

24843

2.912 kg/m

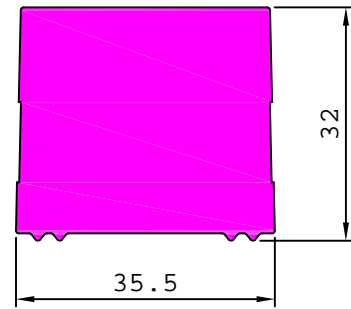

24881

5.541 kg/m

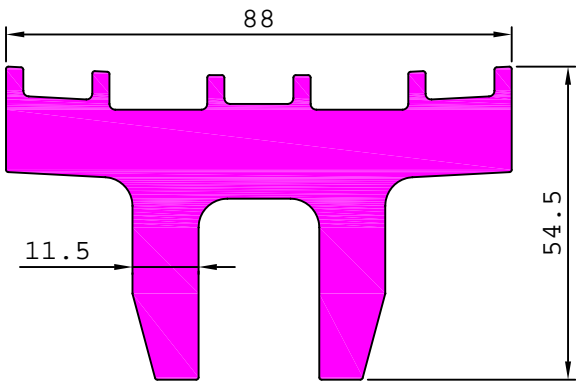

24870

4.152 kg/m

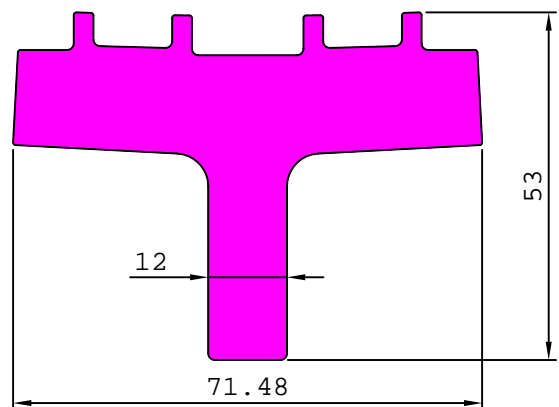

S5700

5.135 kg/m

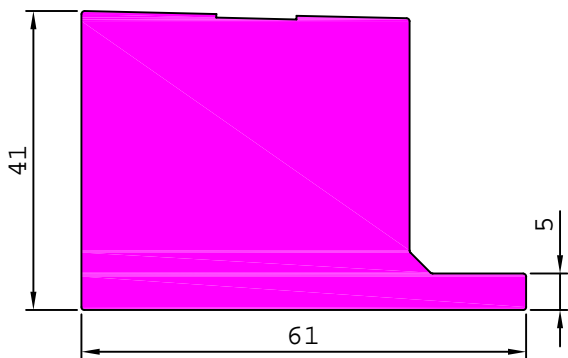

S5775

1.653 kg/m

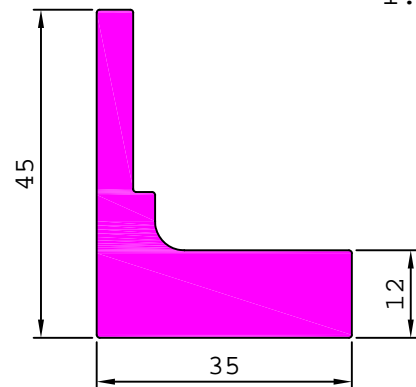

40528

7.436 kg/m

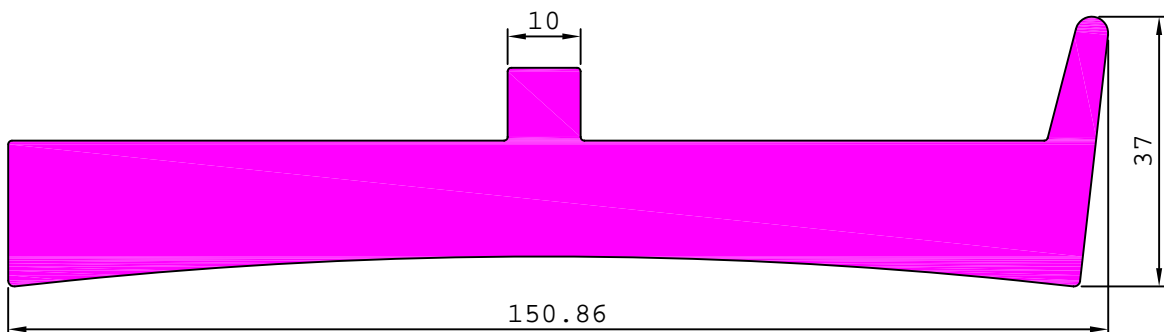



TEXTILE MACHINERY

28342

8.005 kg/m

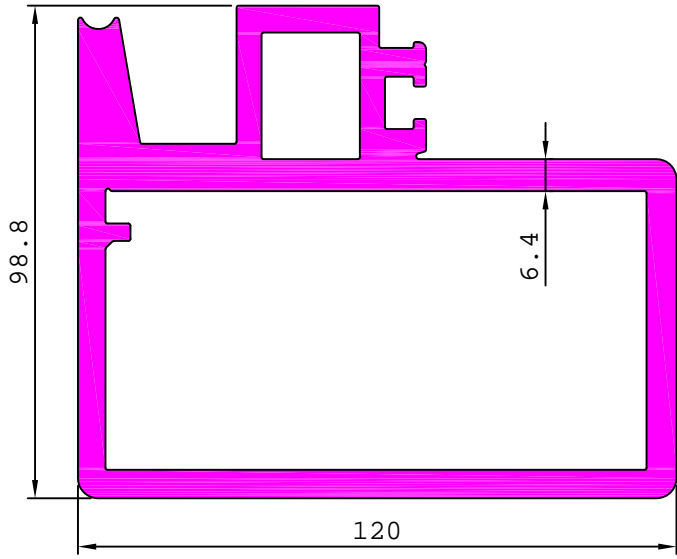

40515

1.839 kg/m

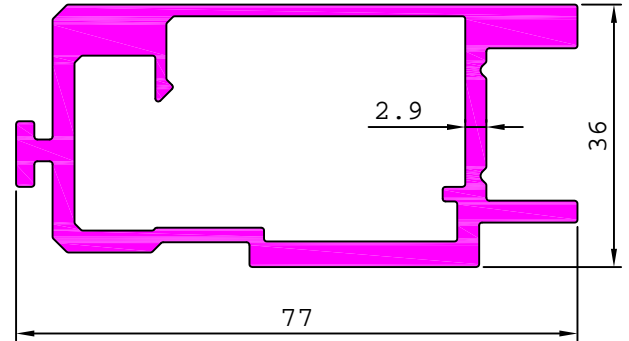

27863

11.327 kg/m

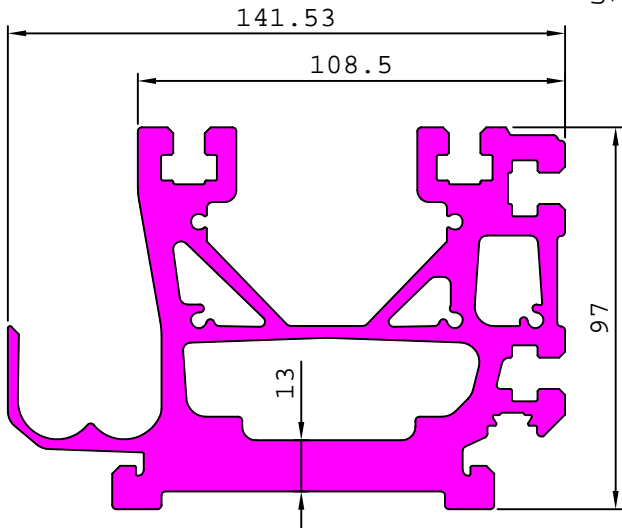

40524

5.159 kg/m

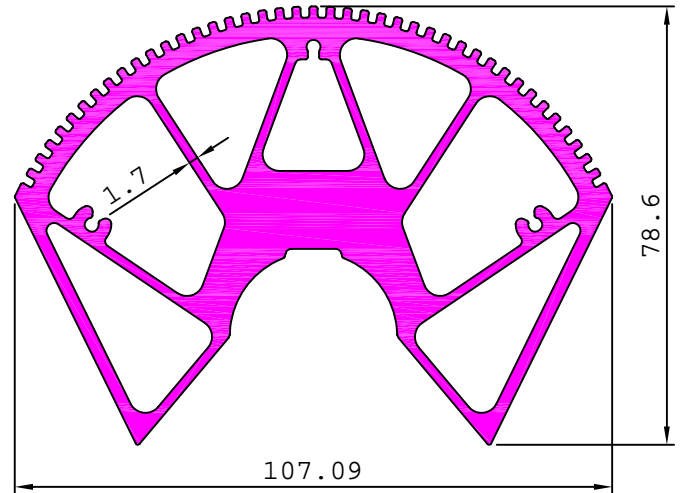

S5477

8.326 kg/m

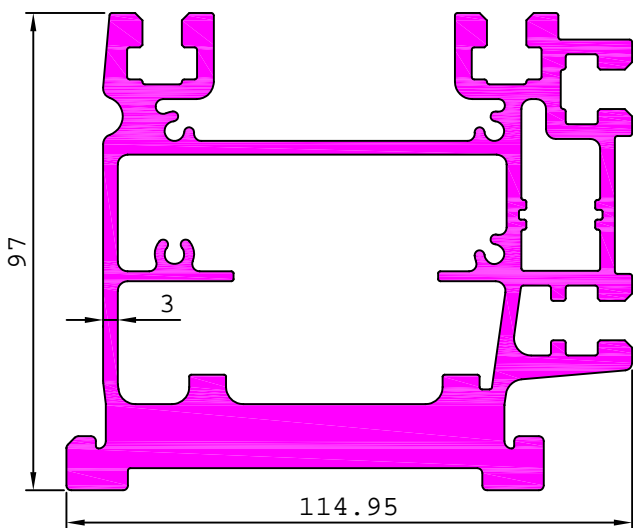

28108

8.000 kg/m

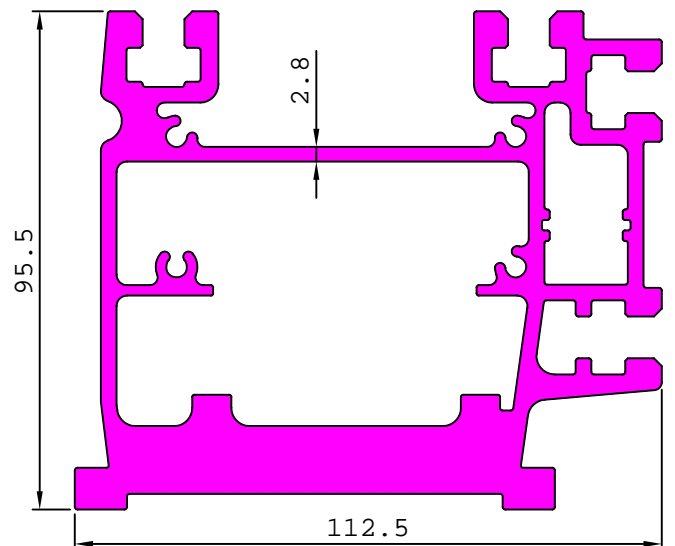

TEXTILE MACHINERY

40529

3.102 kg/m

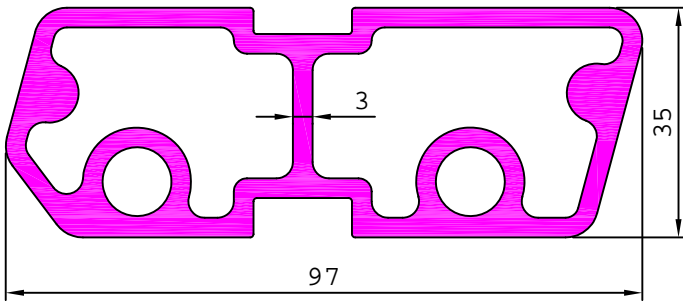

24731

2.223 kg/m

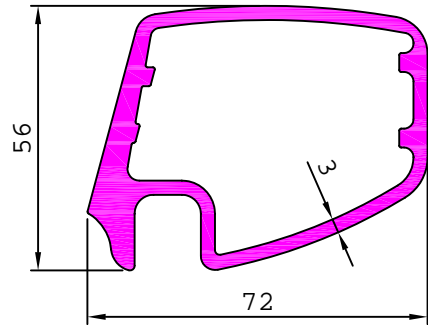

S5434

0.364 kg/m

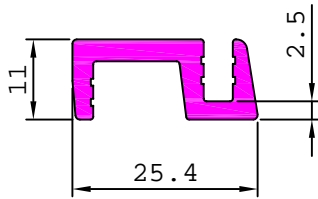

S6191

0.349 kg/m

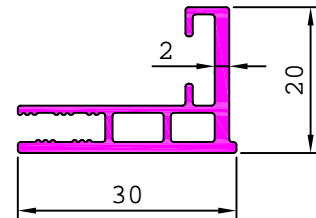

S6361

0.106 kg/m

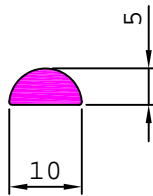

S6362

0.079 kg/m

