

AUTOMOBILE SECTIONS

27490

1.677 kg/m

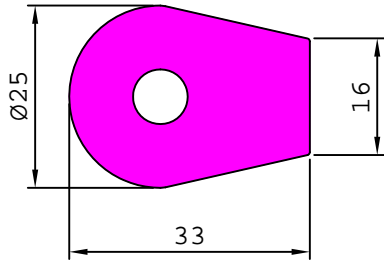

27535

2.761 kg/m

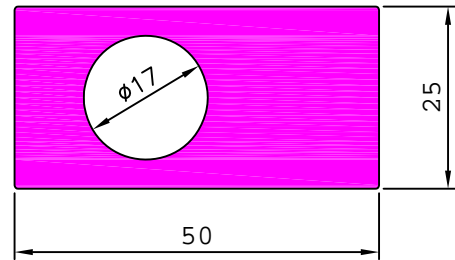

27682

2.548 kg/m

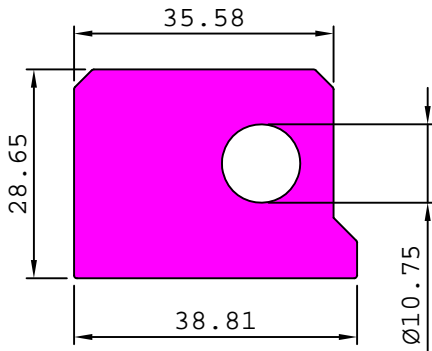

27685

1.851 kg/m

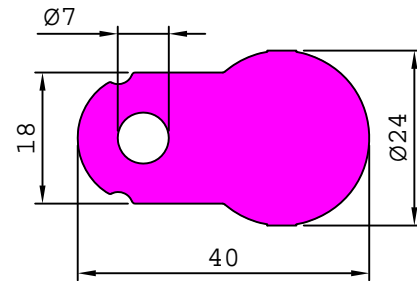

27879

0.991 kg/m

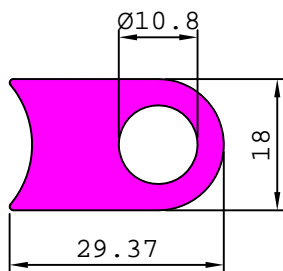

28023

3.908 kg/m

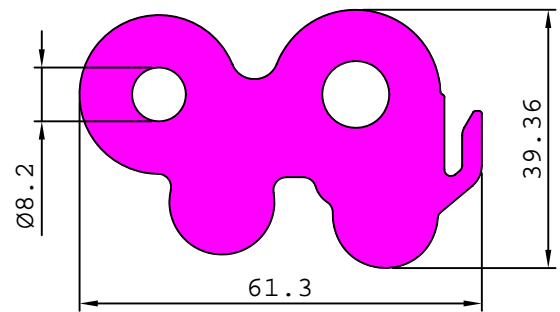

28069

3.391 kg/m

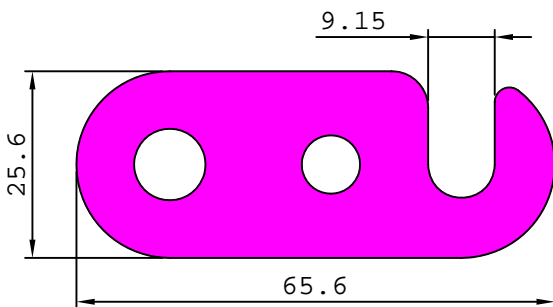

28269

0.987 kg/m

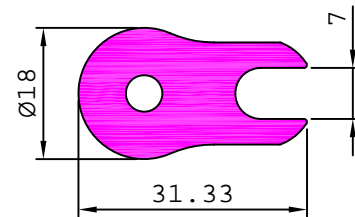

AUTOMOBILE SECTIONS

28082

2.677 kg/m

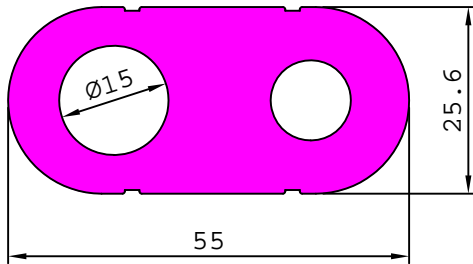

28081

2.239 kg/m

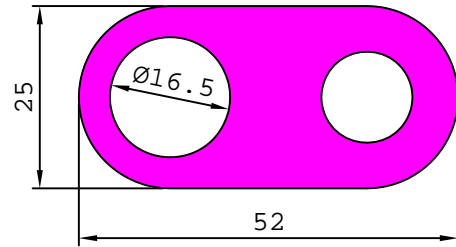

28232

2.108 kg/m

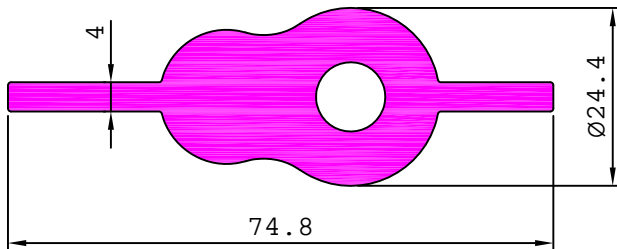

28390

1.586 kg/m

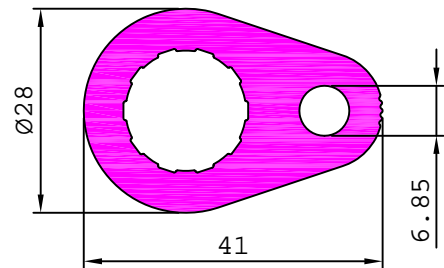

S5701

4.968 kg/m

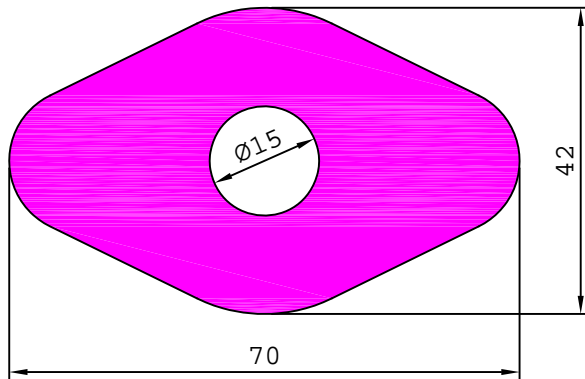

S5703

3.479 kg/m

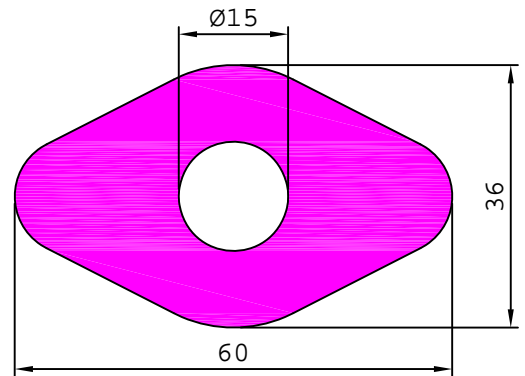

S5887

3.282 kg/m

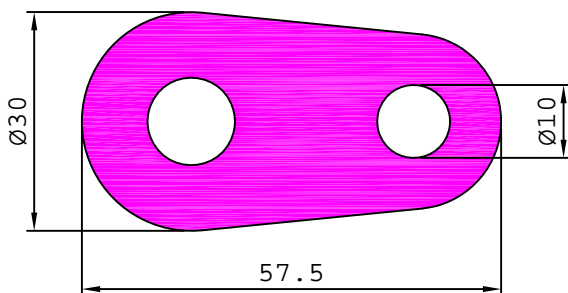

S5915

2.701 kg/m

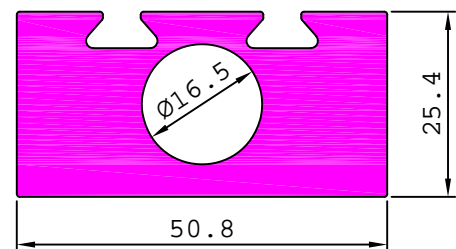

AUTOMOBILE SECTIONS

27793

6.297 kg/m

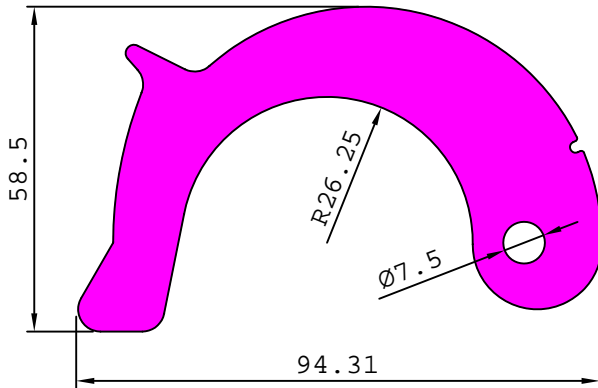

27829

5.416 kg/m

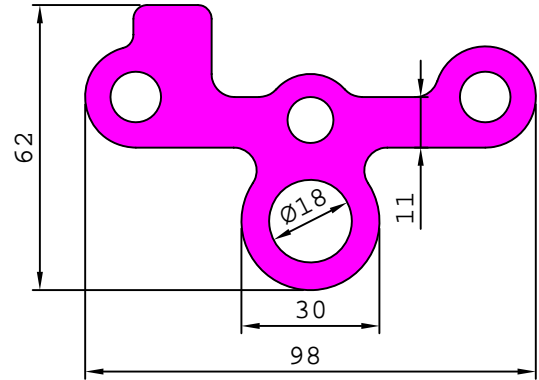

28154

2.529 kg/m

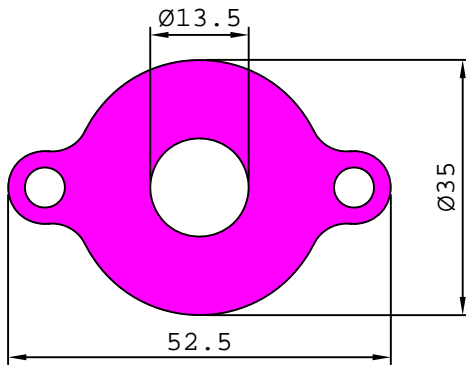

28089

1.791 kg/m

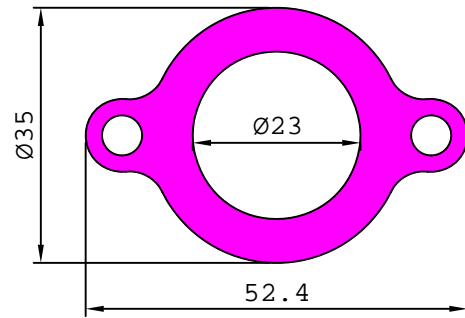

27713

1.879 kg/m

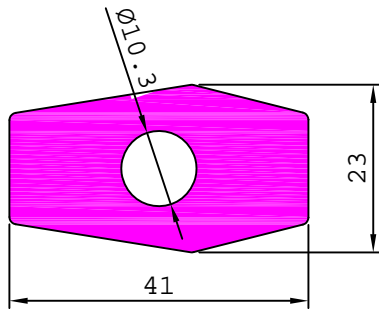

AUTOMOBILE SECTIONS

27769

1.274 kg/m

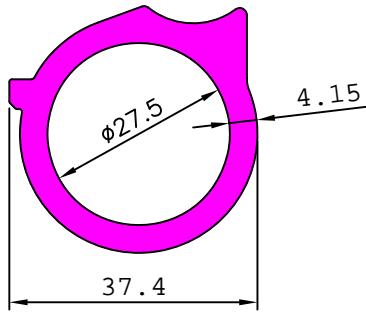

28035

1.237 kg/m

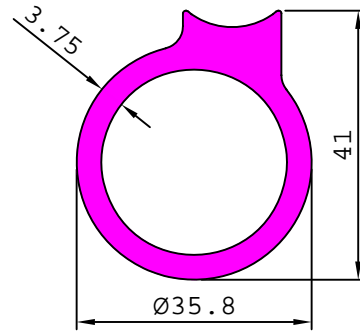

27849

1.254 kg/m

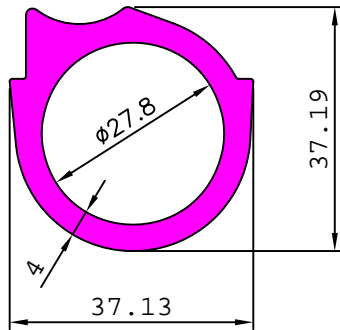

28234

0.944 kg/m

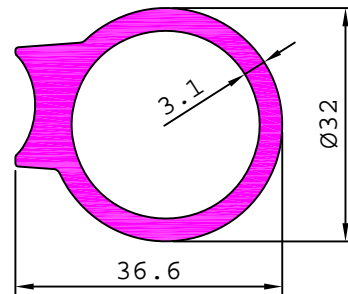

28235

0.668 kg/m

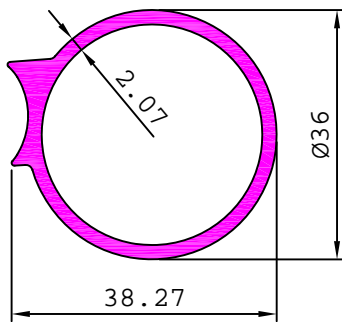

28339

1.122 kg/m

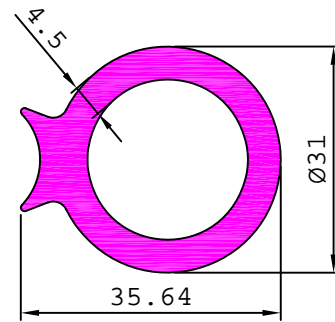

28244

0.728 kg/m

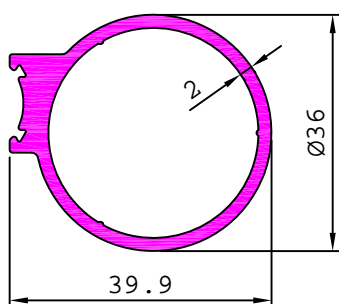

28245

1.096 kg/m

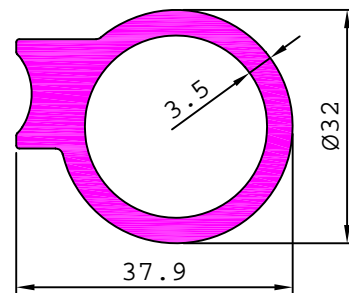

AUTOMOBILE SECTIONS

S5802

1.234 kg/m

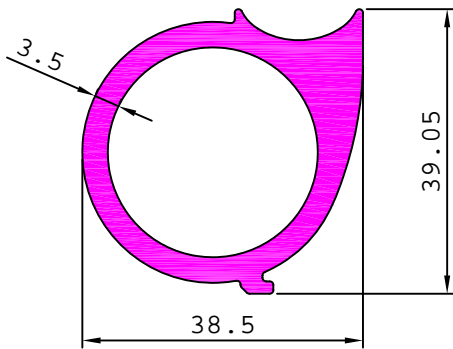

27790

1.420 kg/m

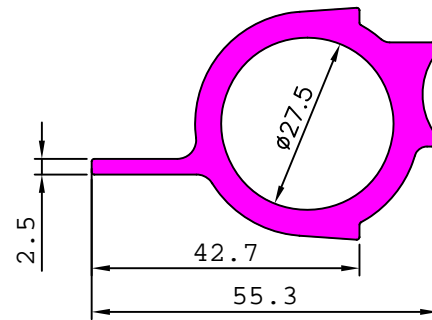

28121

0.625 kg/m

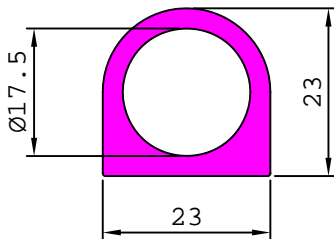

28248

0.311 kg/m

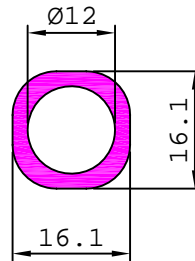

28090

0.210 kg/m

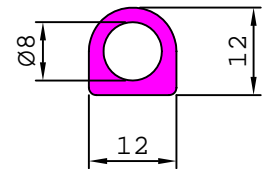

27998

1.345 kg/m

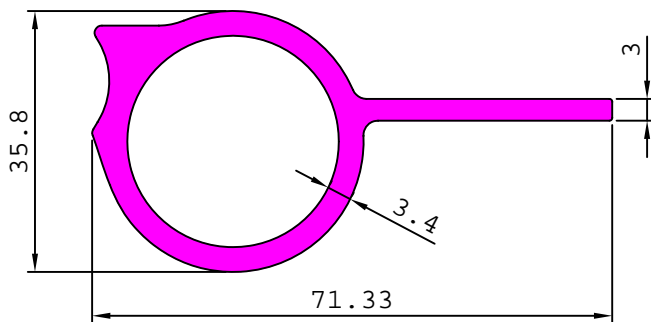

S6289

1.122 kg/m

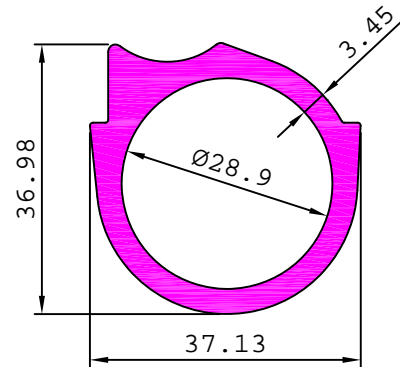

S6331

1.073 kg/m

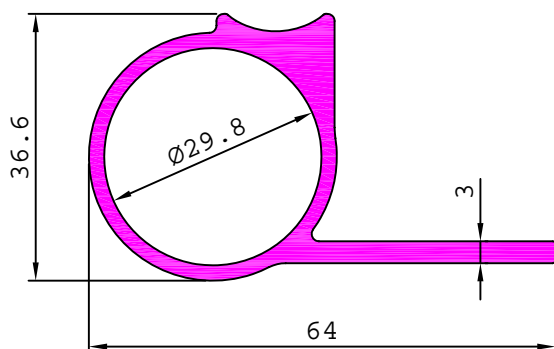

S6458

0.707 kg/m

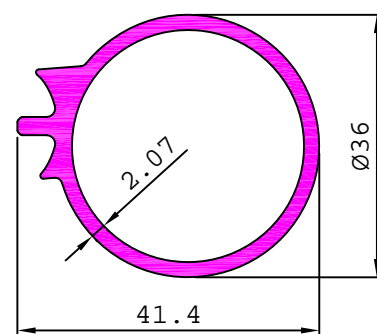

AUTOMOBILE SECTIONS

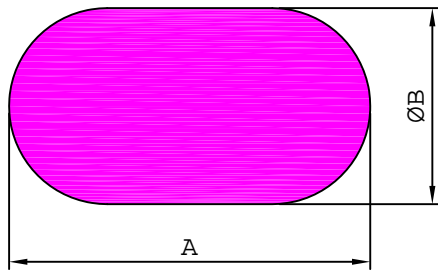

SL. No.	Section No.	A	B	Weight kg/m
1	28328	37.00	16.00	1.450
2	28215	49.00	23.00	2.736
3	28314	51.00	25.60	3.145
4	29032	51.00	25.60	3.145
5	28117	51.60	28.00	3.447
6	28158	65.20	25.20	4.068
7	28961	72.00	27.00	4.826

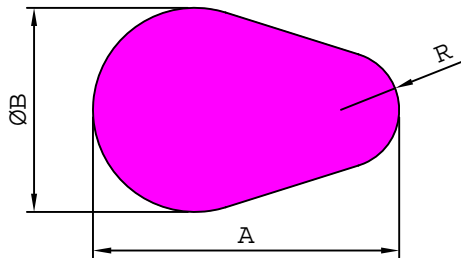

SL. No.	Section No.	A	ØB	R	Weight kg/m
1	28036	33.50	20.00	8.00	1.455
2	28414	39.00	22.00	9.00	1.888
3	28015	42.00	28.00	8.00	2.345
4	28173	43.40	29.40	9.70	2.611
5	S5518	239.00	115.00	25.00	52.288
6	S6432	235.30	100.00	25.00	46.110

27650

1.439 kg/m

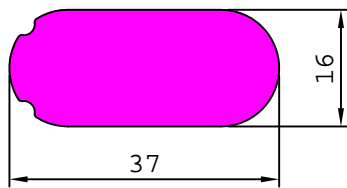

27684

1.137 kg/m

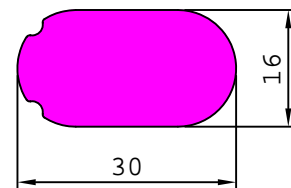

27917

0.757 kg/m

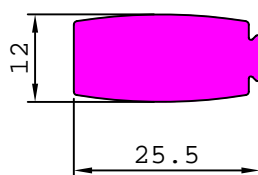

28229

1.748 kg/m

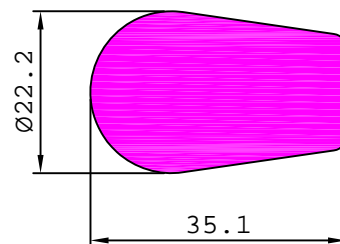

AUTOMOBILE SECTIONS

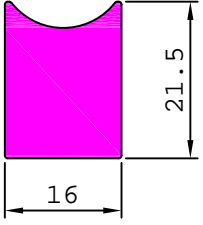
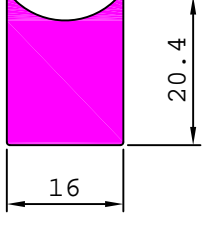
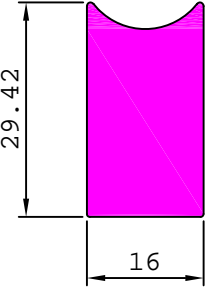
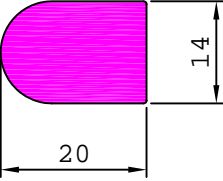
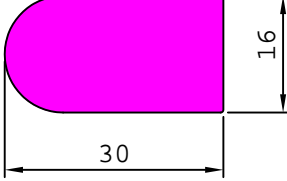
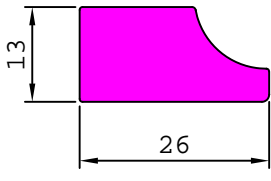
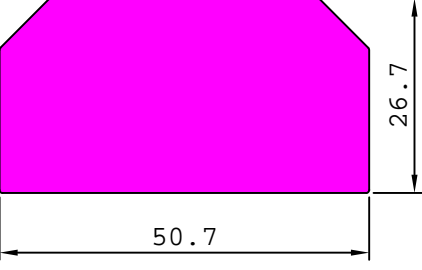
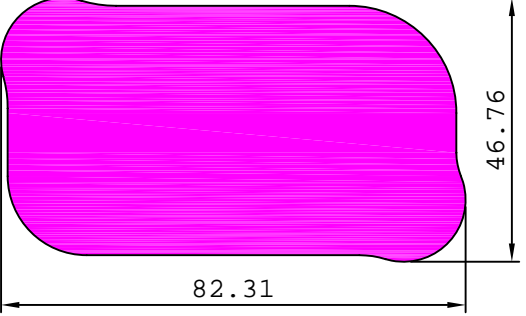
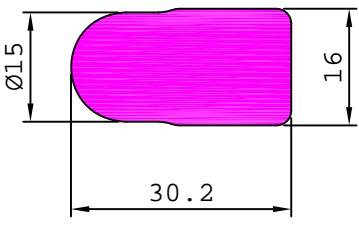
<p>S5502 0.830 kg/m</p> 	<p>S5503 0.790 kg/m</p> 	<p>28365 1.170 kg/m</p> 
<p>28377 0.699 kg/m</p> 	<p>27649 1.222 kg/m</p> 	<p>28140 0.734 kg/m</p> 
<p>28159 3.526 kg/m</p> 	<p>28131 9.233 kg/m</p> 	
<p>S6425 1.198 kg/m</p> 		

AUTOMOBILE SECTIONS

28288

0.433 kg/m

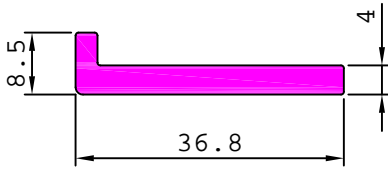

28363

0.377 kg/m

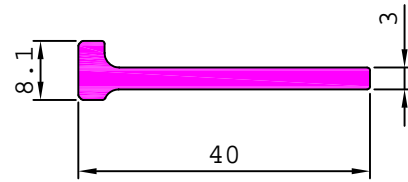

28440

0.291 kg/m

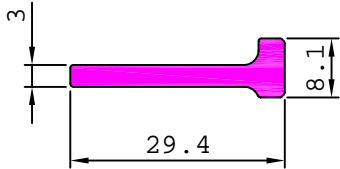

28366

0.356 kg/m

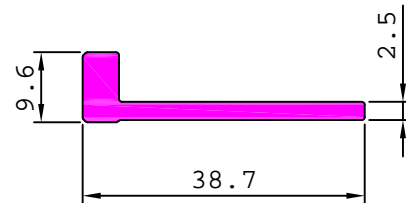

S5397

0.352 kg/m

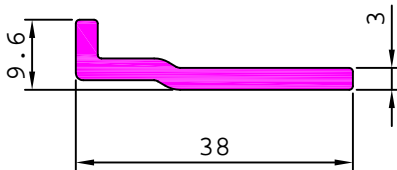

S5398

0.408 kg/m

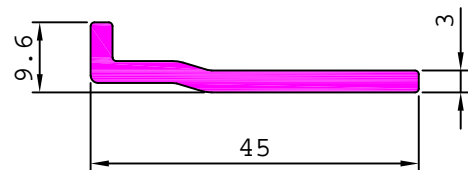

S5413

0.354 kg/m

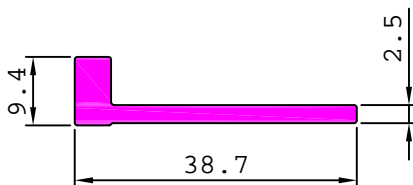

27711

0.801 kg/m

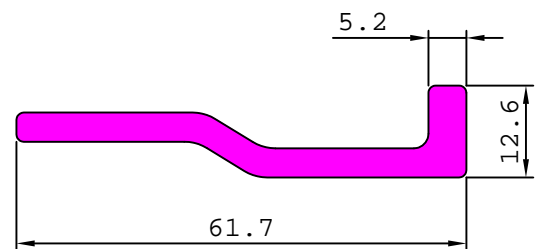

AUTOMOBILE SECTIONS

27633

2.128 kg/m

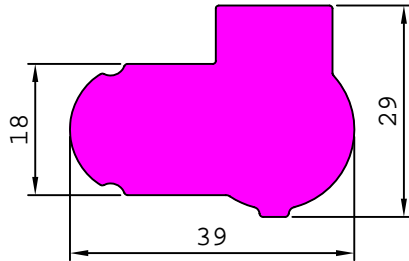

27634

1.838 kg/m

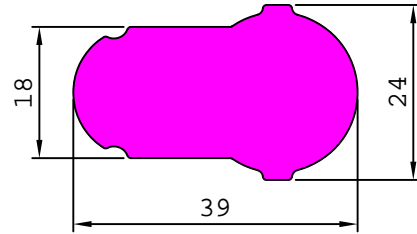

27641

1.955 kg/m

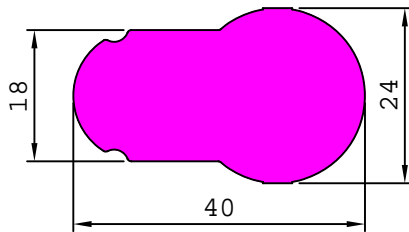

27644

4.123 kg/m

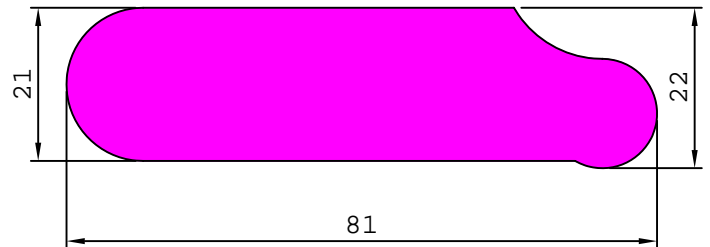

27695

3.321 kg/m

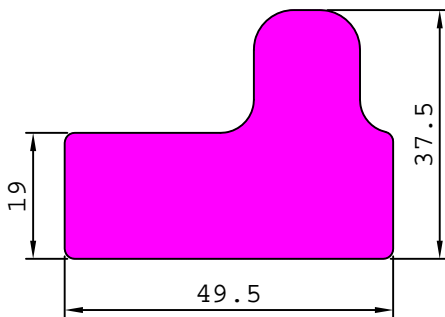

27664

2.143 kg/m

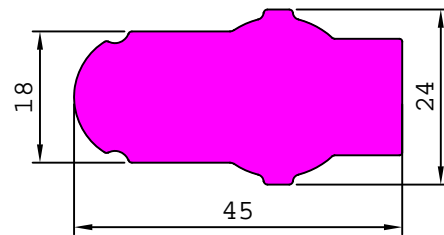

27703

1.305 kg/m

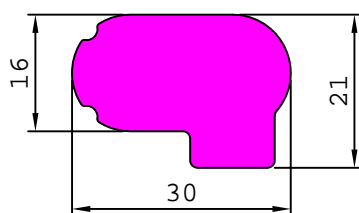

27738

1.341 kg/m

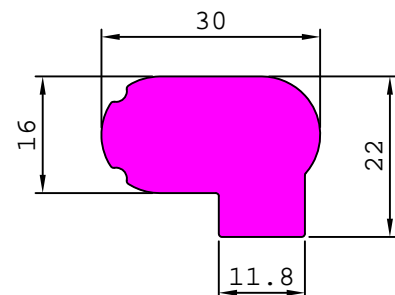

AUTOMOBILE SECTIONS

27748

2.269 kg/m

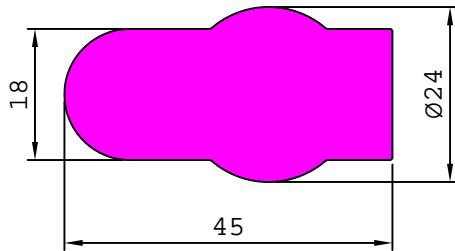

27764

1.656 kg/m

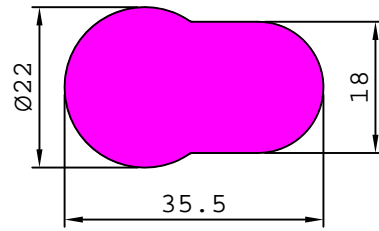

27768

2.468 kg/m

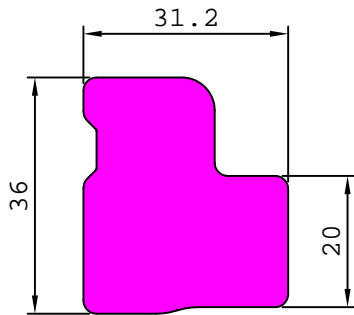

27770

2.960 kg/m

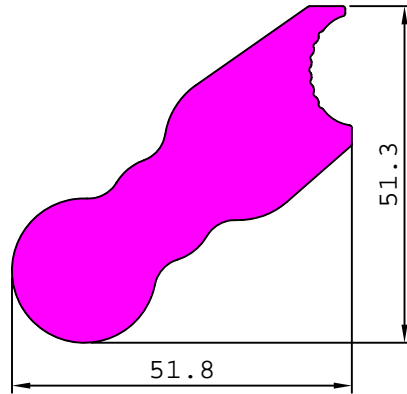

27791

0.896 kg/m

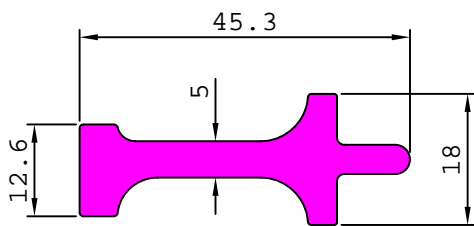

27858

0.570 kg/m

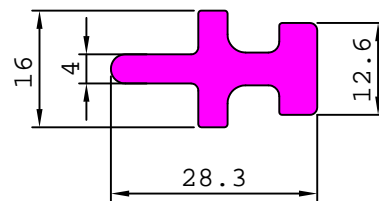

27862

2.540 kg/m

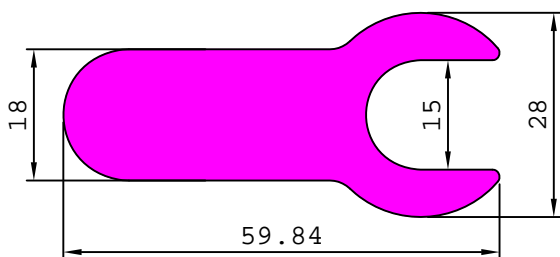

27873

1.349 kg/m

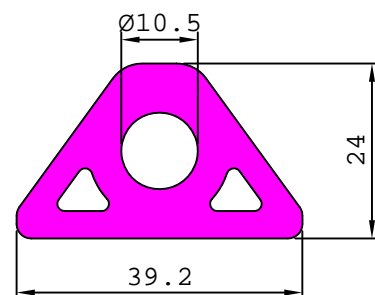

AUTOMOBILE SECTIONS

27933

2.632 kg/m

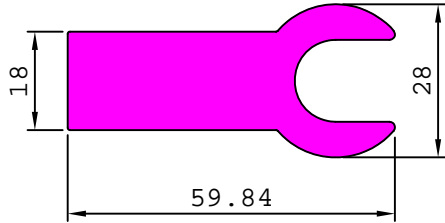

27907

0.937 kg/m

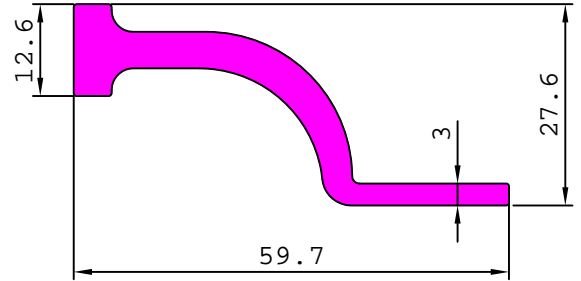

27959

3.956 kg/m

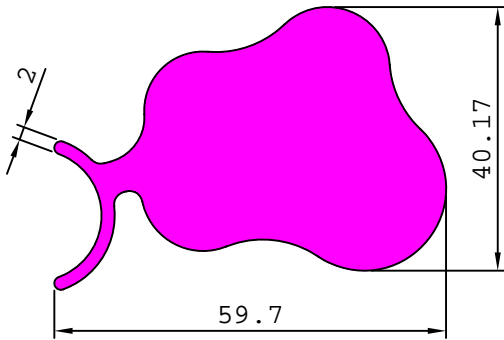

28016

2.227 kg/m

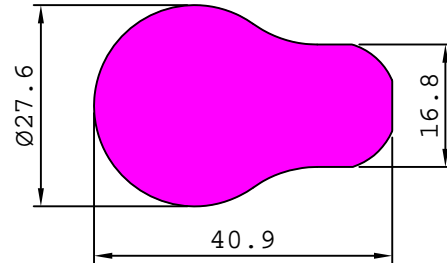

28037

2.785 kg/m

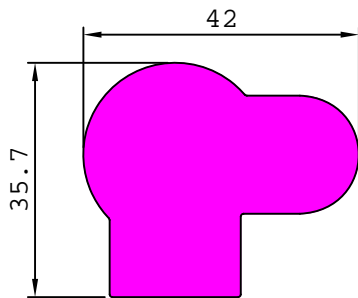

28038

2.250 kg/m

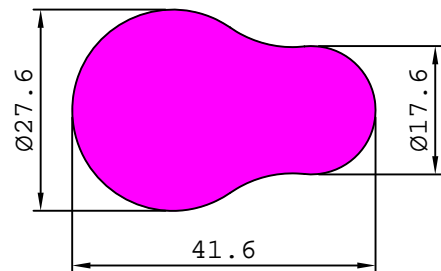

28051

4.147 kg/m

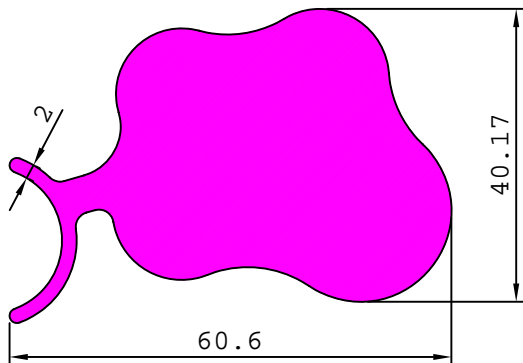

28055

3.478 kg/m

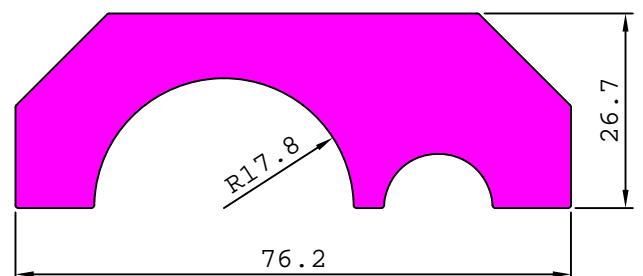

AUTOMOBILE SECTIONS

28059

3.986 kg/m

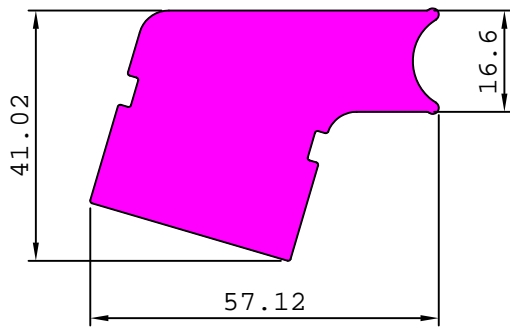

28065

2.421 kg/m

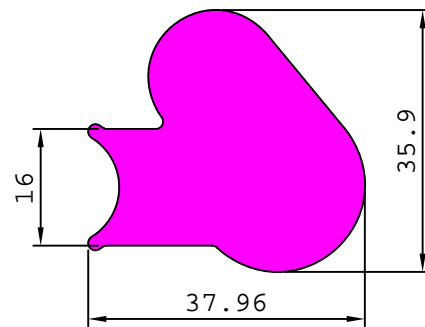

28074

2.021 kg/m

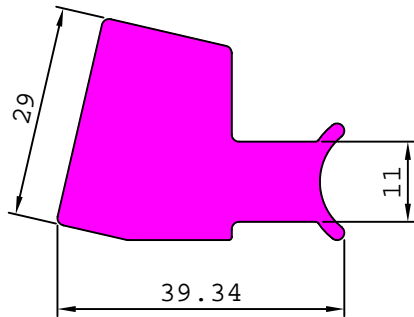

28094

2.234 kg/m

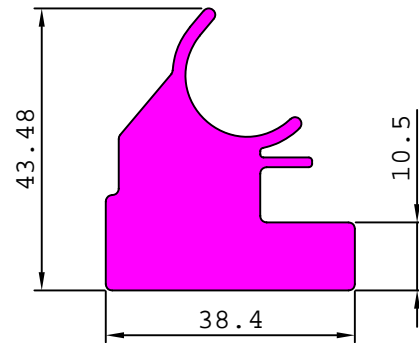

28075

2.403 kg/m

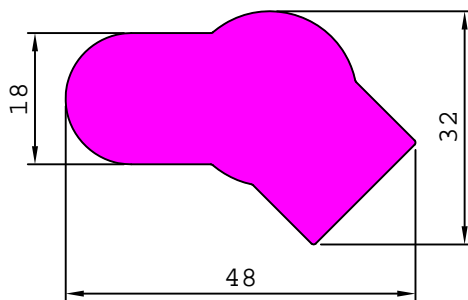

28083

1.883 kg/m

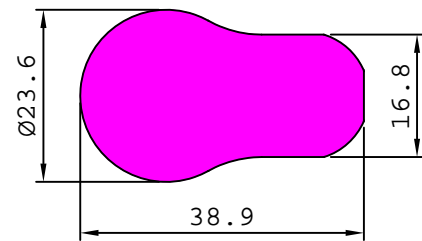

28091

2.412 kg/m

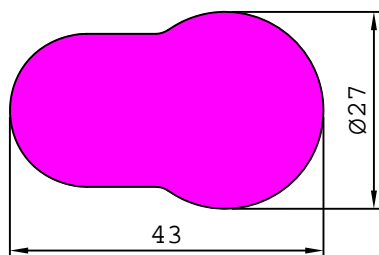

28093

1.147 kg/m

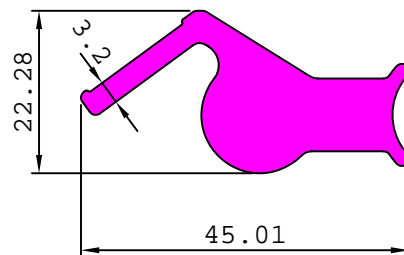

AUTOMOBILE SECTIONS

28156

0.965 kg/m

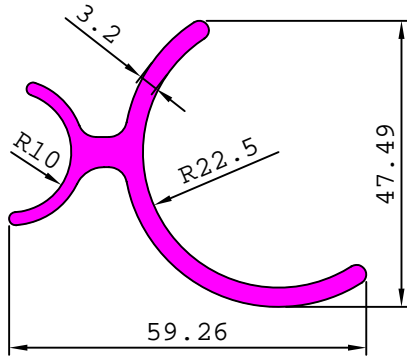

28157

1.168 kg/m

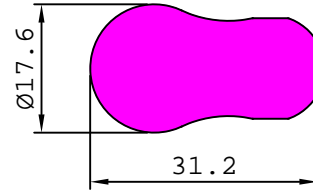

28174

2.840 kg/m

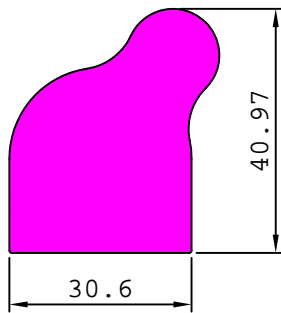

28195

2.652 kg/m

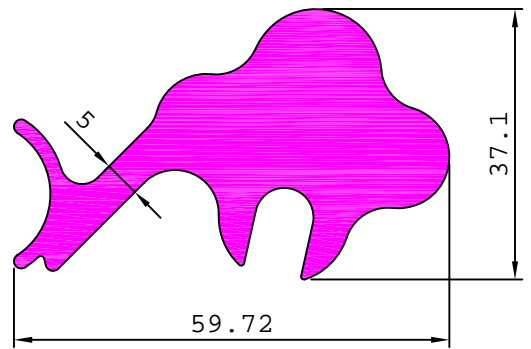

28175

1.873 kg/m

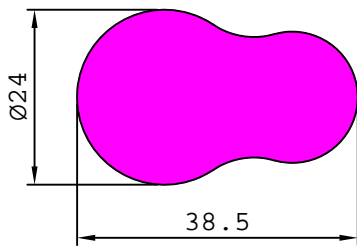

28169

2.358 kg/m

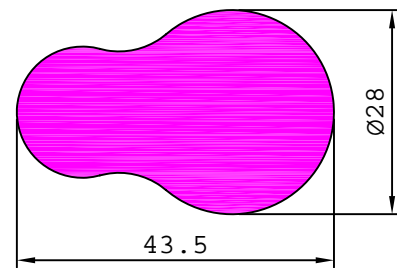

28124

5.715 kg/m

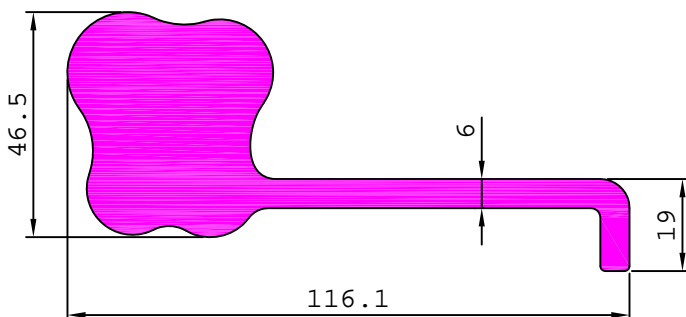

28211

4.309 kg/m

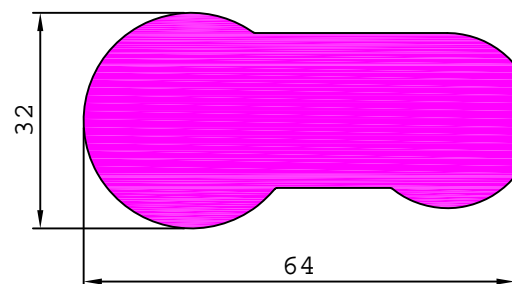

AUTOMOBILE SECTIONS

28153

2.197 kg/m

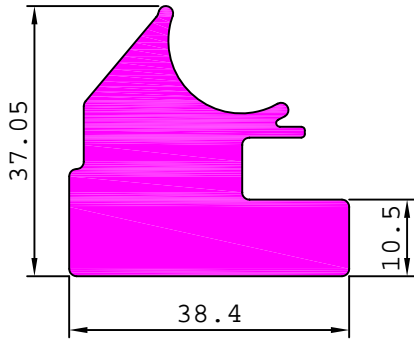

28260

2.534 kg/m

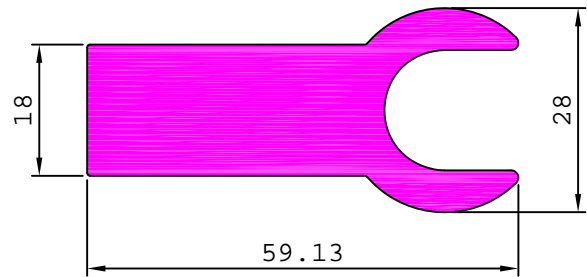

28249

0.372 kg/m

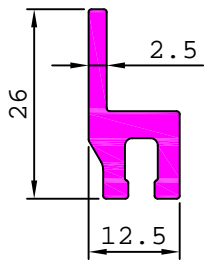

28148

0.408 kg/m

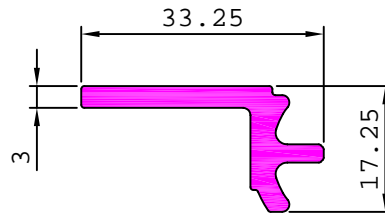

28149

0.514 kg/m

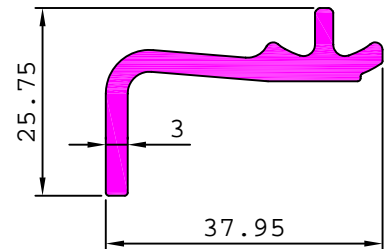

29179

1.256 kg/m

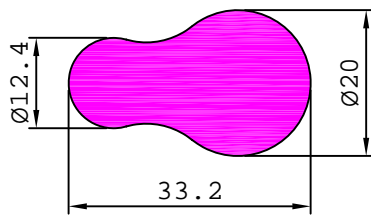

29321

1.966 kg/m

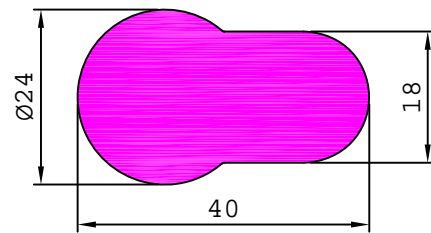

29402

2.053 kg/m

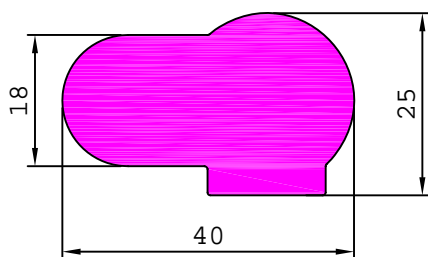

29340

0.726 kg/m

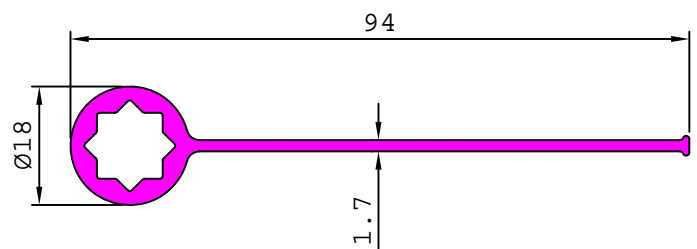

AUTOMOBILE SECTIONS

29358

1.069 kg/m

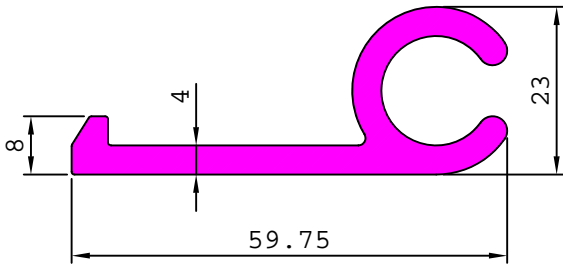

28189

3.070 kg/m

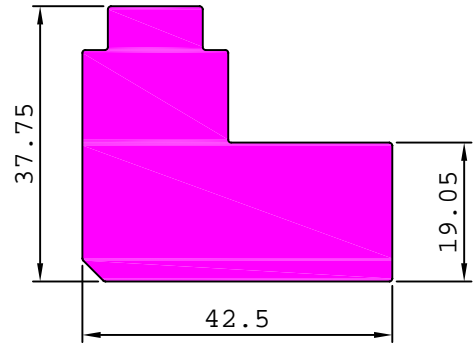

28233

2.068 kg/m

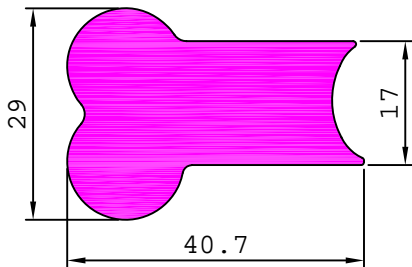

28306

0.759 kg/m

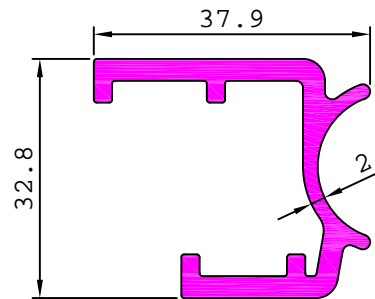

28307

0.667 kg/m

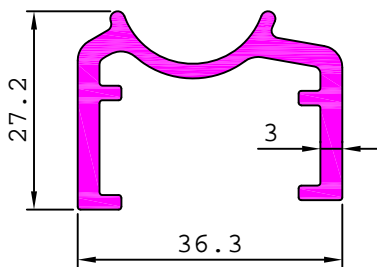

28308

0.718 kg/m

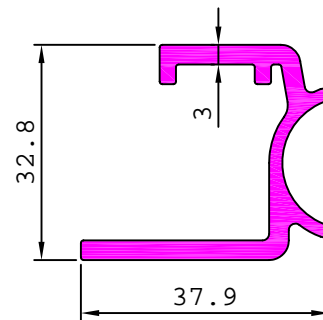

28309

0.637 kg/m

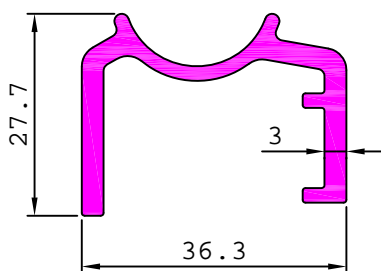

28278

2.149 kg/m

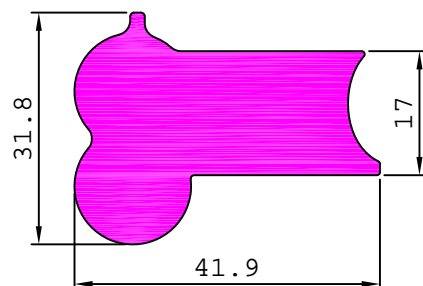

AUTOMOBILE SECTIONS

28281

1.525 kg/m

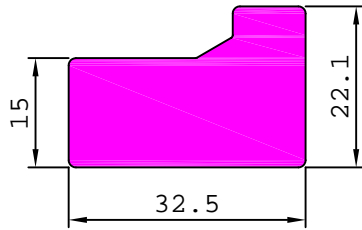

28298

2.596 kg/m

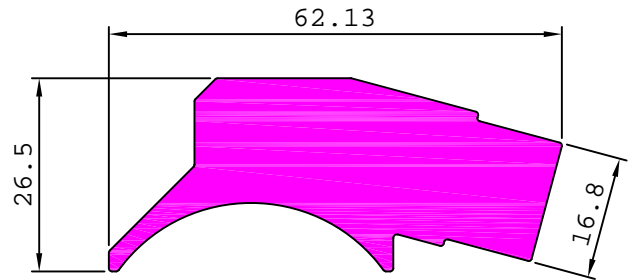

28361

2.150 kg/m

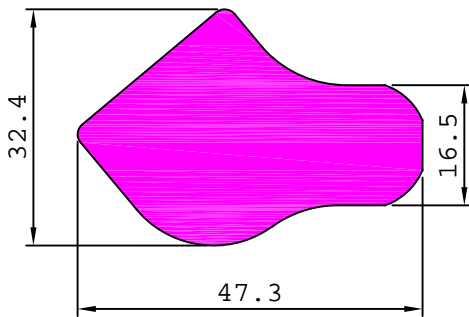

28386

1.772 kg/m

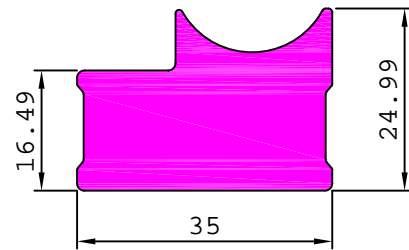

28321

2.996 kg/m

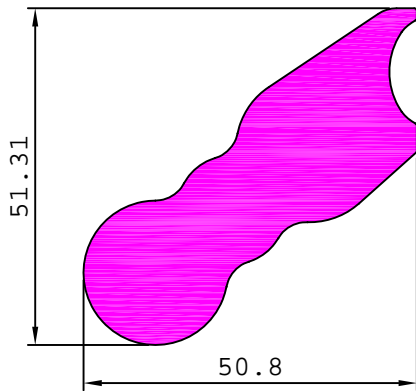

28405

4.867 kg/m

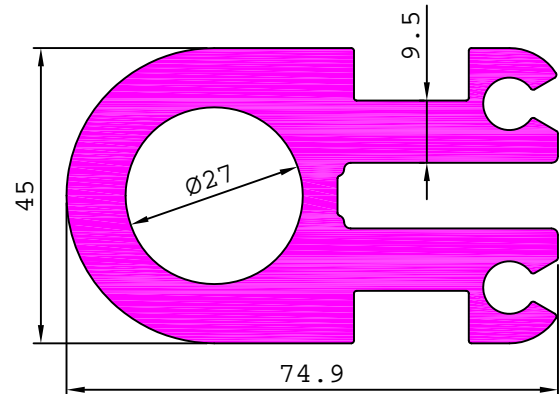

28416

1.080 kg/m

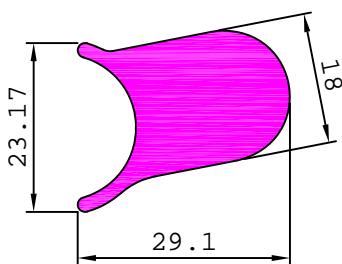

28419

1.787 kg/m

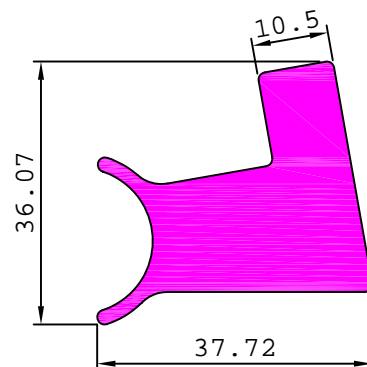

AUTOMOBILE SECTIONS

28394

2.142 kg/m

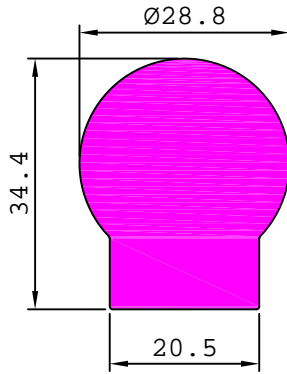

28425

5.273 kg/m

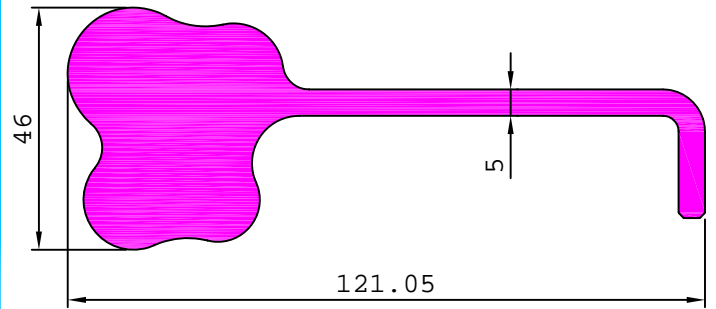

S4404

10.990 kg/m

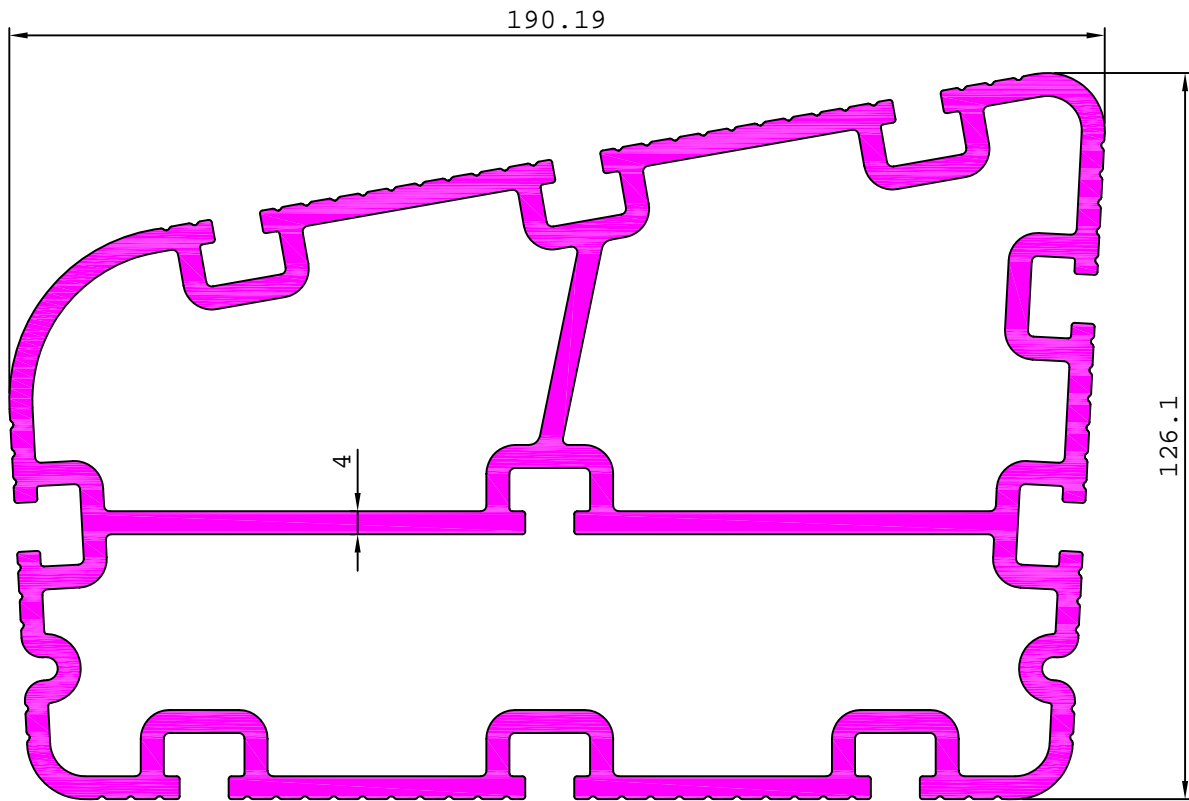

28430

1.344 kg/m

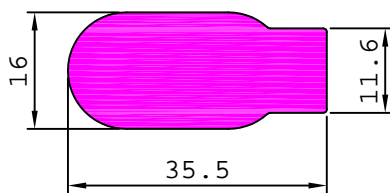

28431

2.489 kg/m

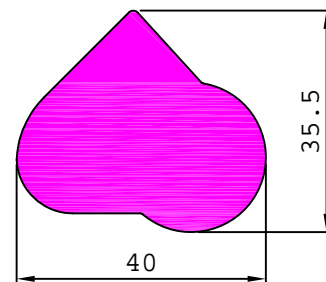

AUTOMOBILE SECTIONS

28442

1.182 kg/m

S5623

0.883 kg/m

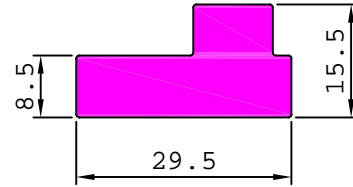
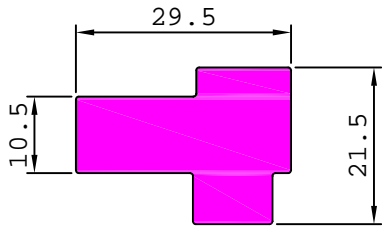

S5760

0.679 kg/m

S5762

0.700 kg/m

S5803

1.363 kg/m

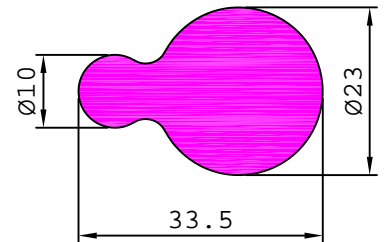
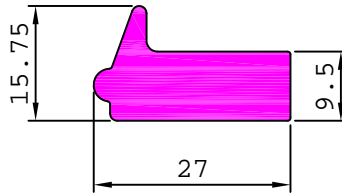
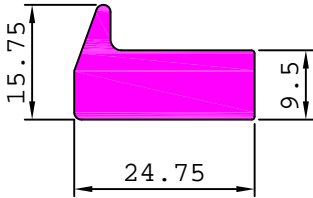

S5761

1.216 kg/m

S5763

1.260 kg/m

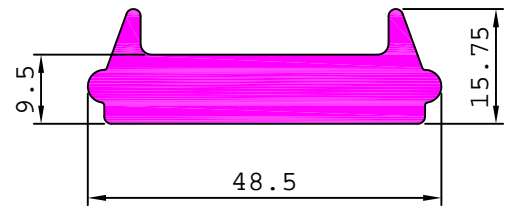
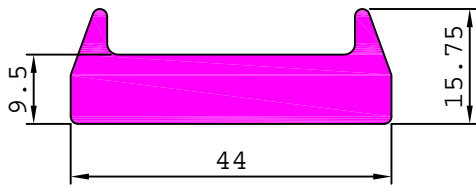

S5804

1.130 kg/m

S5916

0.292 kg/m

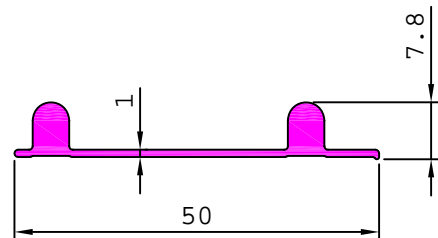
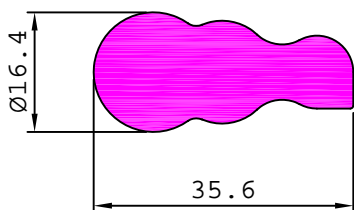

AUTOMOBILE SECTIONS

S5896

2.014 kg/m

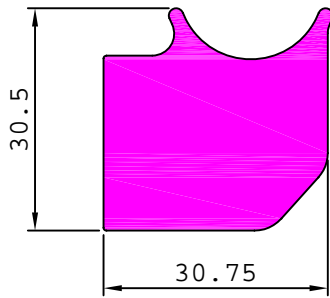

S5897

1.705 kg/m

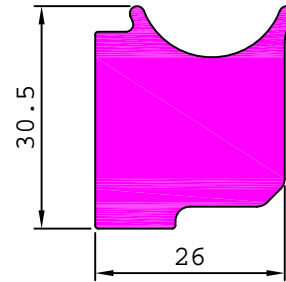

S5952

1.473 kg/m

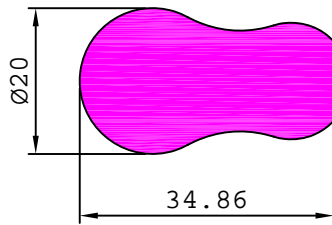

28438

1.942 kg/m

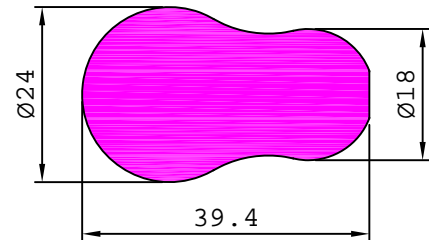

S5975

1.922 kg/m

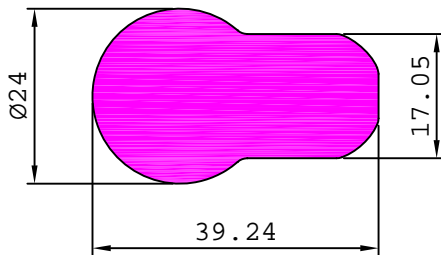

S6075

1.047 kg/m

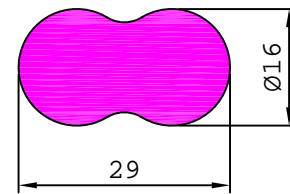

S6077

3.853 kg/m

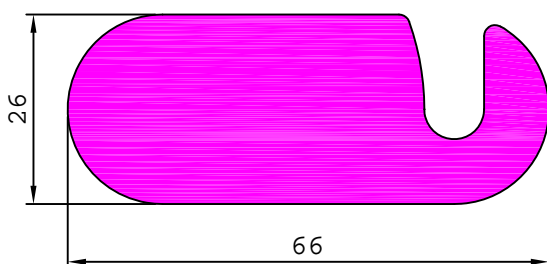

S6076

2.459 kg/m

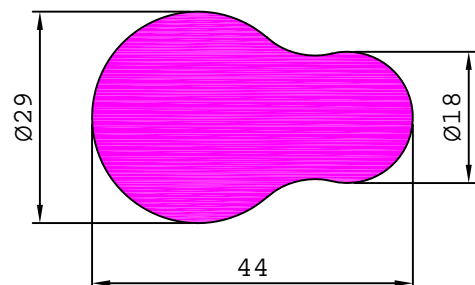

AUTOMOBILE SECTIONS

28424

7.764 kg/m

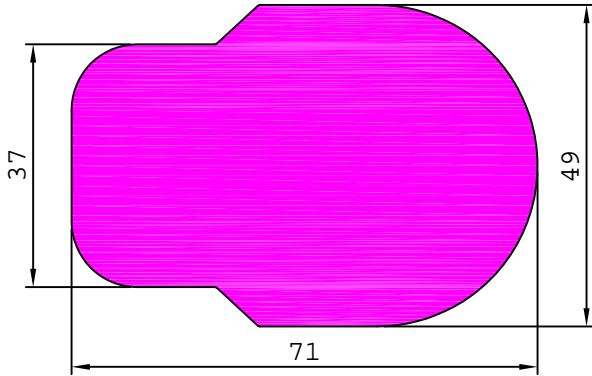

28423

6.283 kg/m

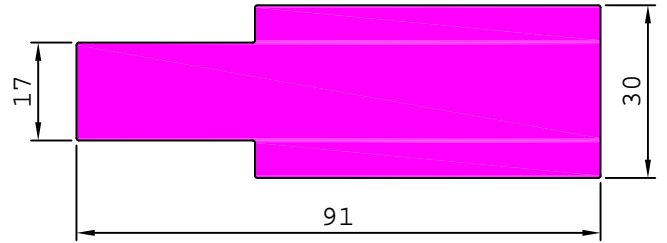

29680

2.594 kg/m

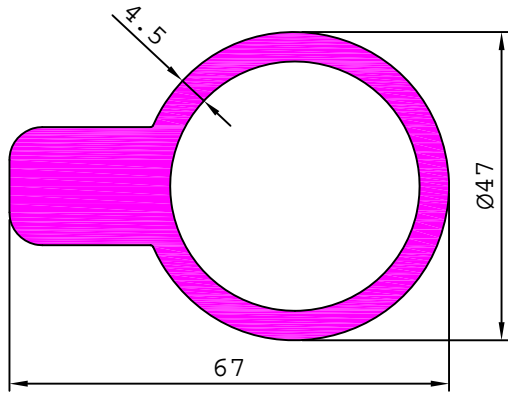

28394

2.142 kg/m

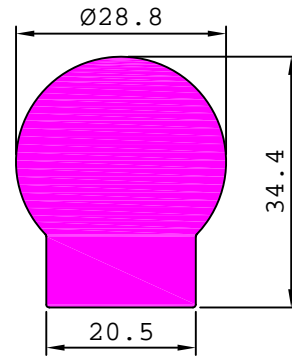

S5751

2.377 kg/m

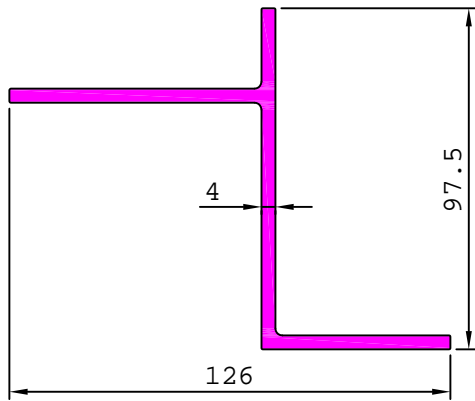

S6096

0.602 kg/m

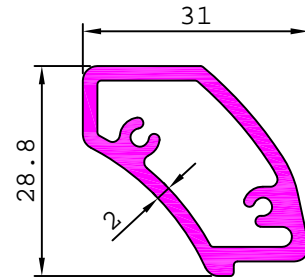

S5974

0.162 kg/m

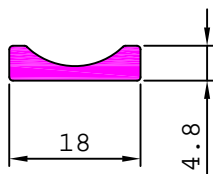

S6332

3.784 kg/m

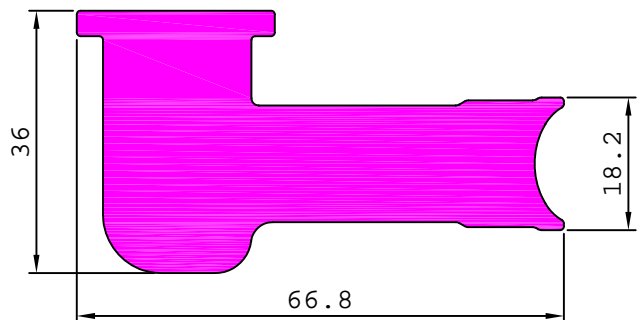



AUTOMOBILE SECTIONS

S6349

2.184 kg/m

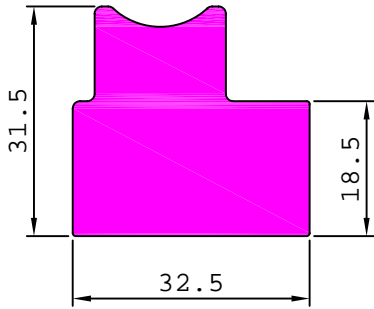

S6426

1.692 kg/m

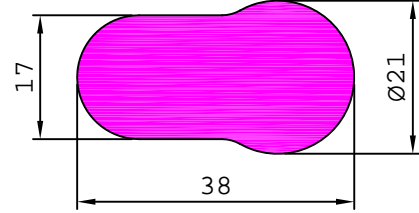

S6292

0.877 kg/m

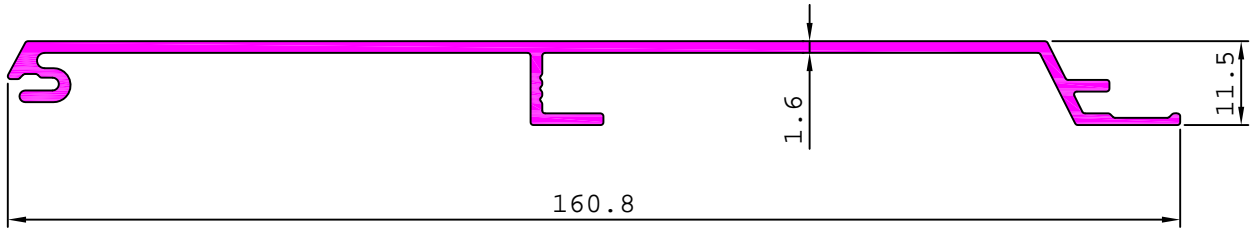

AUTOMOBILE SECTIONS

27708 1.162 kg/m

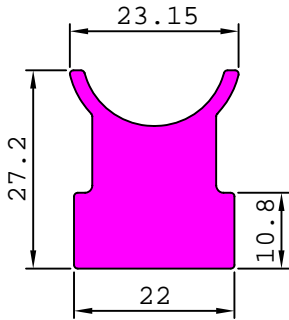

27709 0.704 kg/m

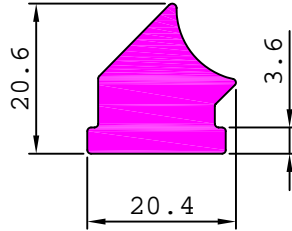

27876 1.231 kg/m

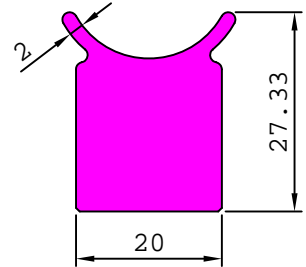

27865 1.228 kg/m

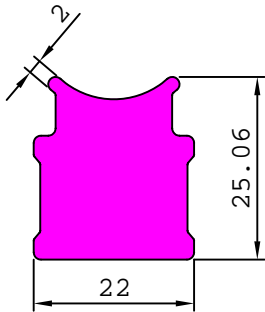

27878 1.213 kg/m

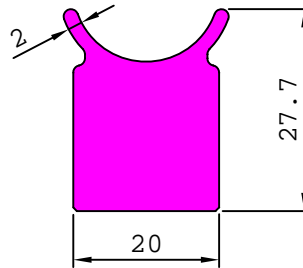

27892 1.558 kg/m

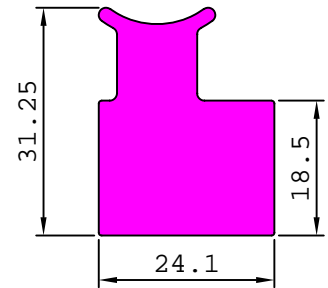

27960 1.367 kg/m

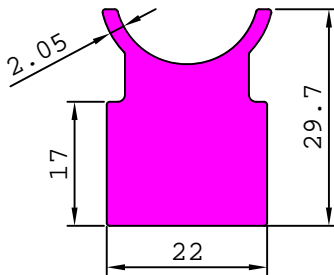

27979 1.372 kg/m

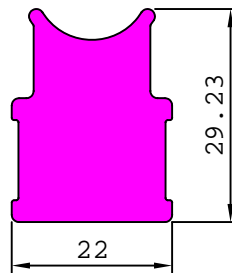

27980 1.670 kg/m

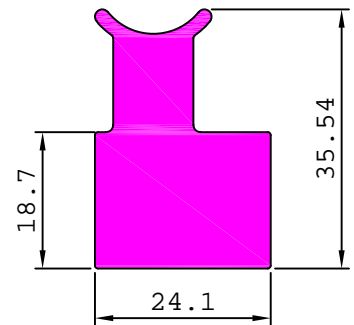

27987 2.183 kg/m

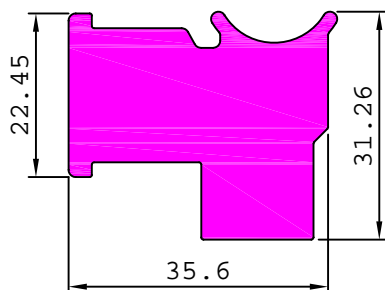

28110 1.131 kg/m

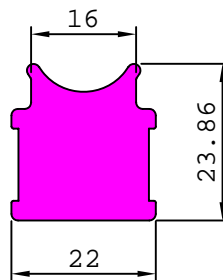

28207 1.230 kg/m

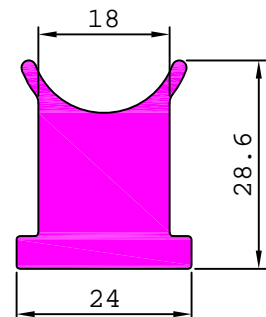

AUTOMOBILE SECTIONS

28255 1.426 kg/m

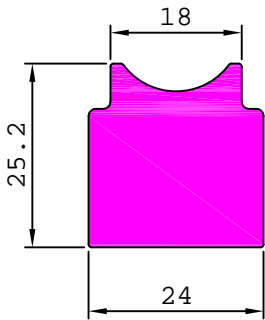

28188 1.881 kg/m

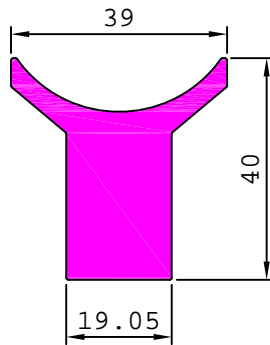

28261 1.548 kg/m

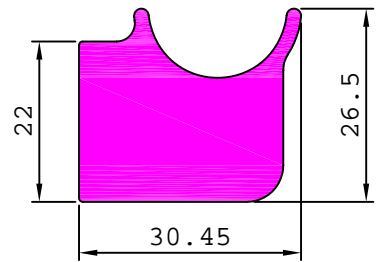

28266 1.685 kg/m

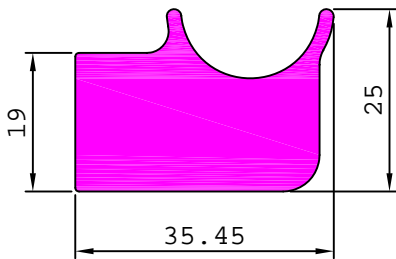

S5743 1.286 kg/m

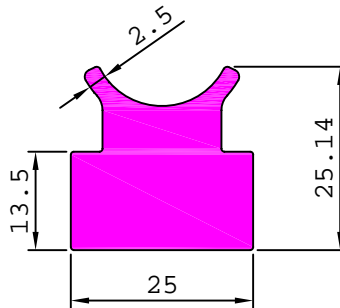

28364 1.031 kg/m

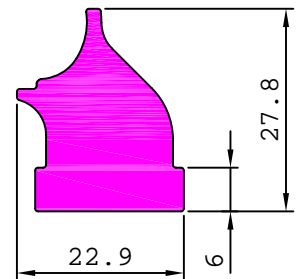

28338 1.775 kg/m

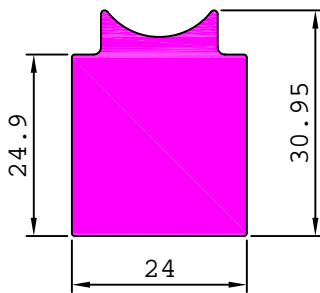

S5386 1.218 kg/m

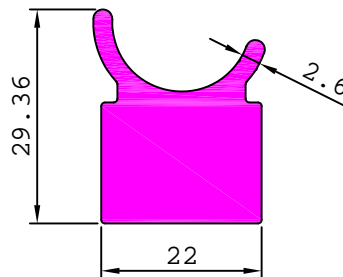

28340 1.880 kg/m

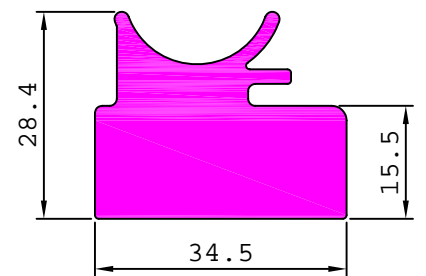

28407 1.376 kg/m

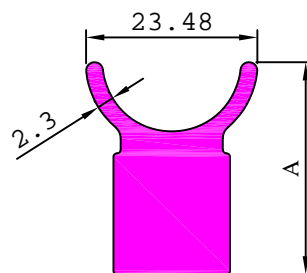
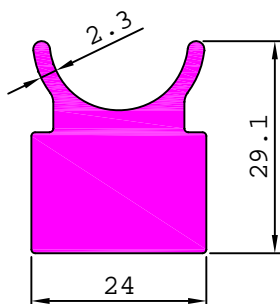

S5999 1.378 kg/m

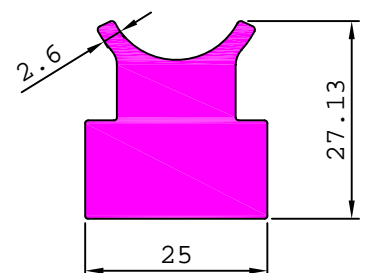

SL. No.	Section No.	A	Weight kg/m
1	28436	29.10	0.976
2	28437	43.00	1.577



AUTOMOBILE SECTIONS

S6312

1.035 kg/m

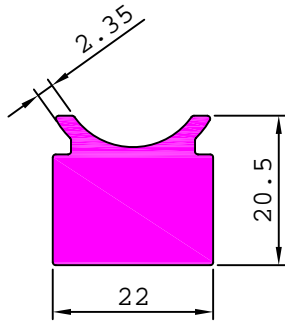

S6311

0.920 kg/m

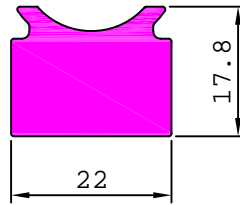

AUTOMOBILE SECTIONS

27972

0.647 kg/m

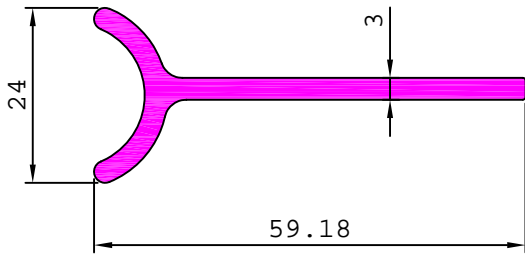

27982

0.717 kg/m

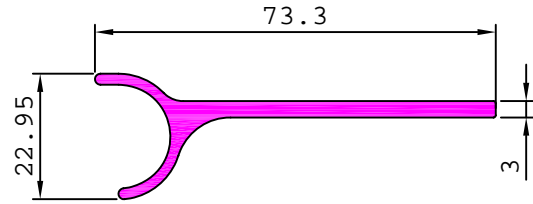

27949

0.728 kg/m

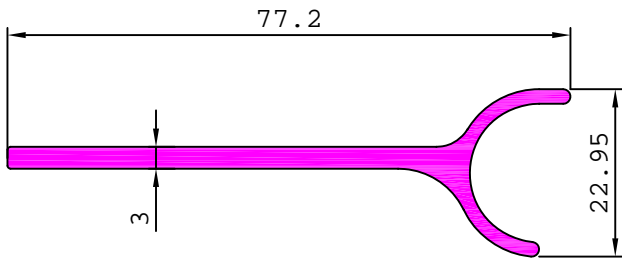

27983

0.885 kg/m

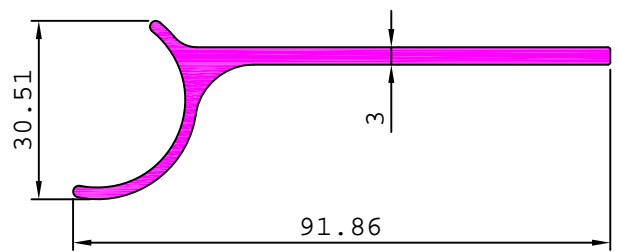

28009

0.397 kg/m

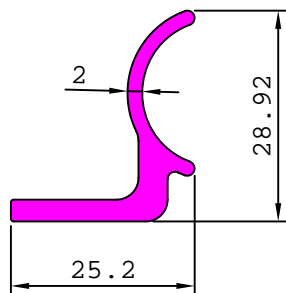

28008

0.792 kg/m

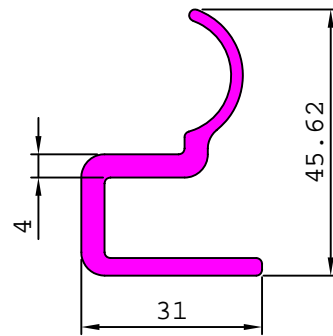

28024

1.022 kg/m

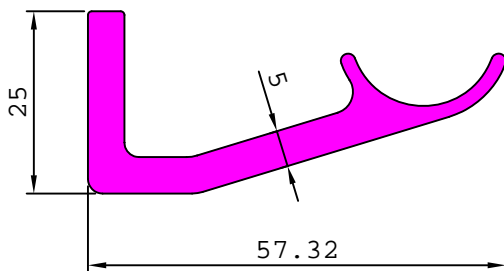

28044

1.791 kg/m

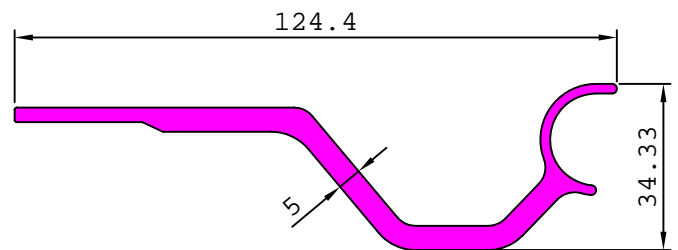

AUTOMOBILE SECTIONS

28092

0.617 kg/m

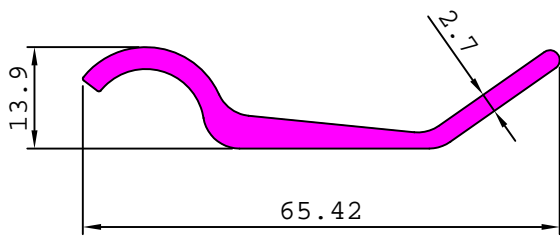

28116

1.097 kg/m

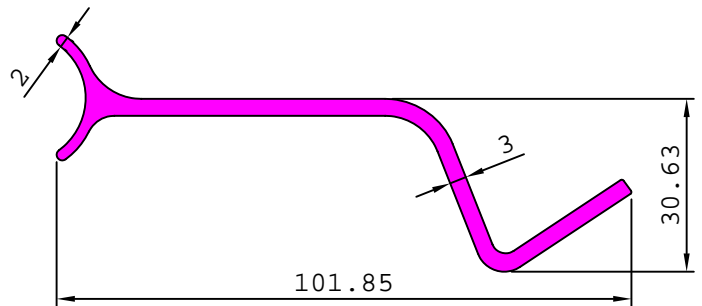

28250

0.873 kg/m

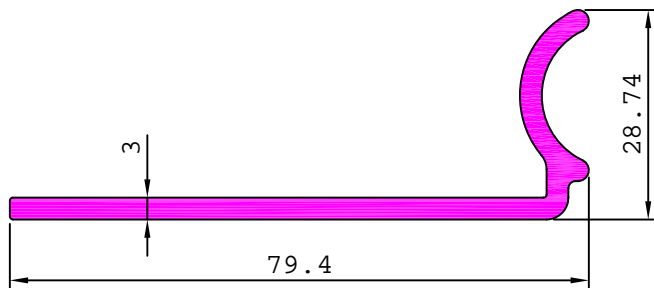

28286

0.498 kg/m

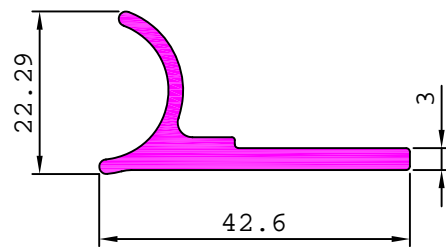

28290

0.365 kg/m

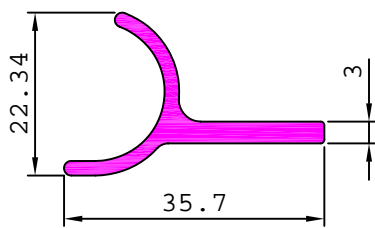

28291

0.463 kg/m

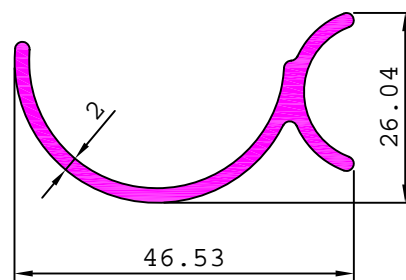

28401

0.517 kg/m

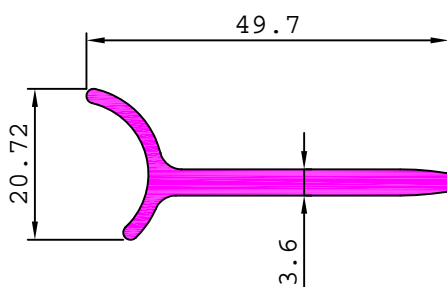

28413

0.665 kg/m

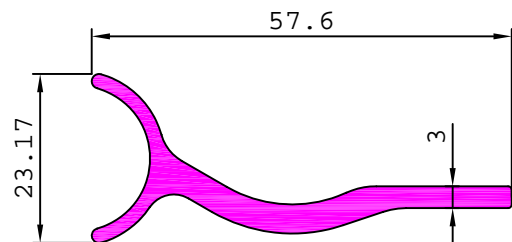

AUTOMOBILE SECTIONS

28417

0.667 kg/m

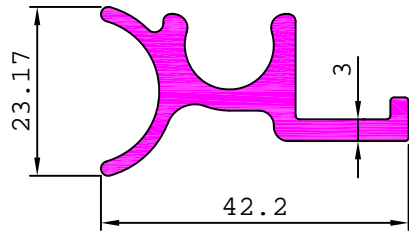

28415

0.445 kg/m

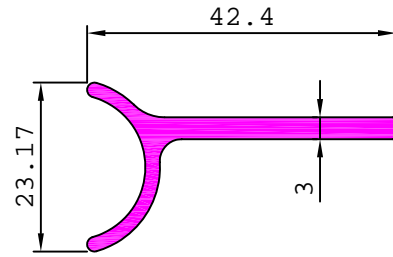

28418

0.694 kg/m

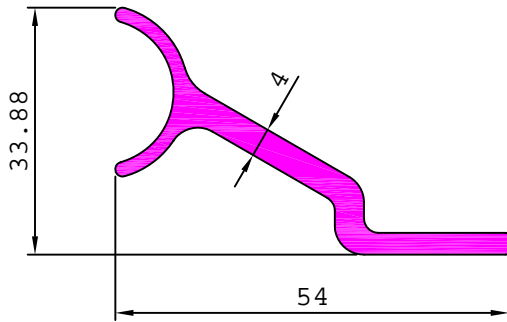

S6330

0.533 kg/m

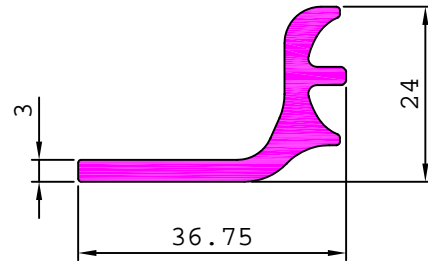

AUTOMOBILE SECTIONS

27874

1.434 kg/m

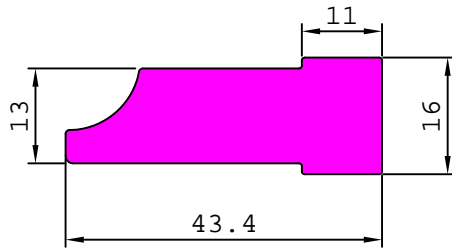

28084

1.405 kg/m

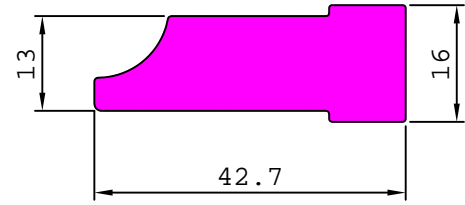

27854

1.297 kg/m

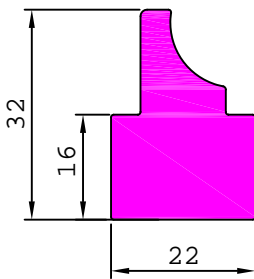

27857

0.823 kg/m

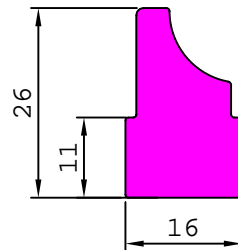

27906

1.172 kg/m

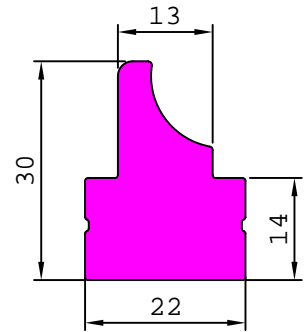

27985

1.243 kg/m

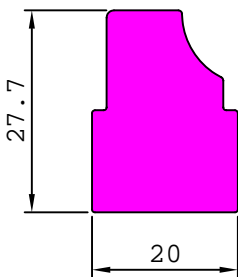

27986

1.230 kg/m

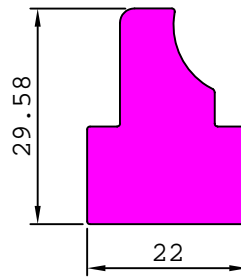

28022

1.561 kg/m

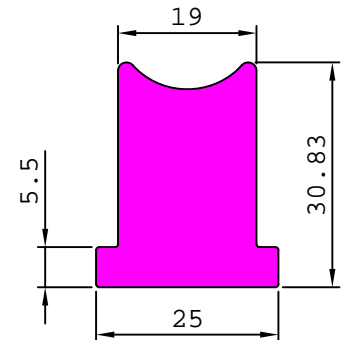

28052

1.131 kg/m

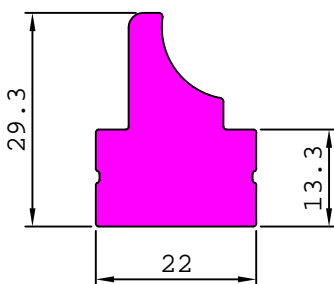

28118

1.256 kg/m

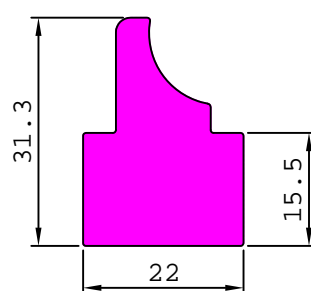

28139

1.408 kg/m

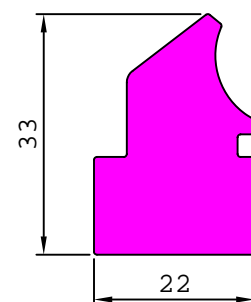

AUTOMOBILE SECTIONS

28133 1.313 kg/m

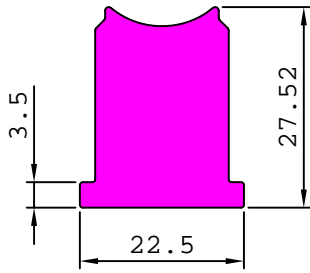

28132 2.168 kg/m

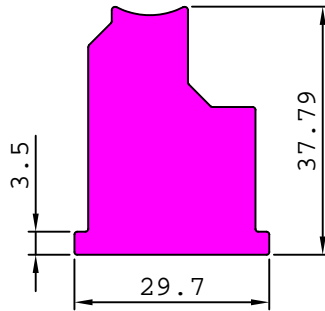

28143 0.884 kg/m

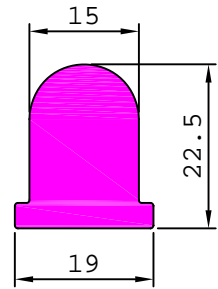

28199 1.208 kg/m

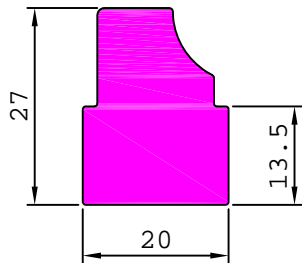

28200 1.193 kg/m

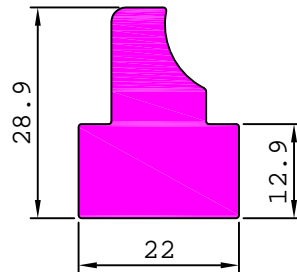

28125 0.794 kg/m

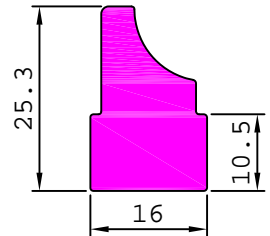

28170 1.317 kg/m

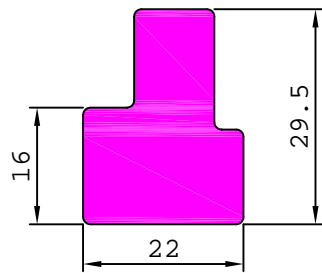

28254 1.403 kg/m

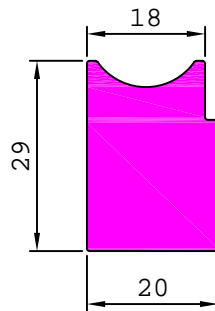

S5387 1.049 kg/m

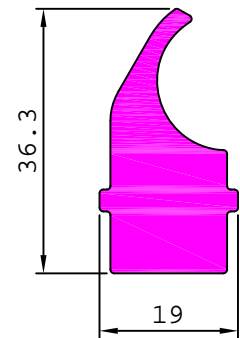

S5396 1.292 kg/m

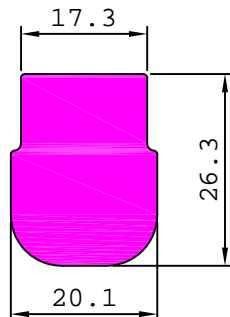

S5744 0.841 kg/m

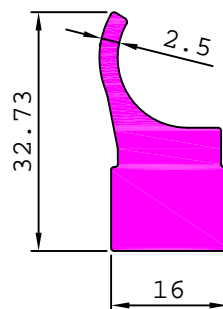

S6000 0.898 kg/m

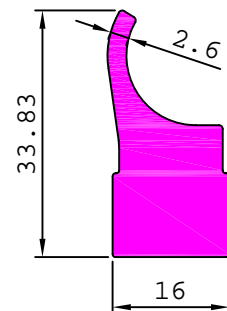



AUTOMOBILE SECTIONS

S5504

2.389 kg/m

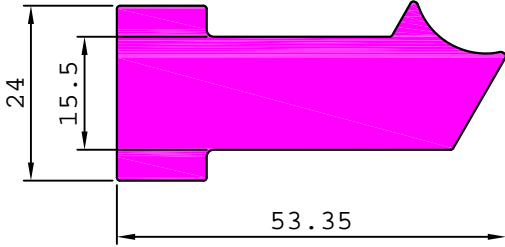

S6218

1.297 kg/m

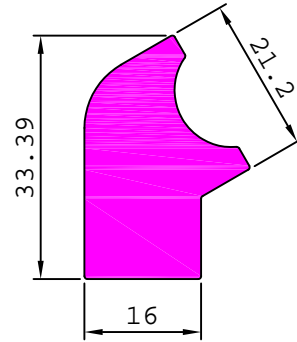

S6217

1.598 kg/m

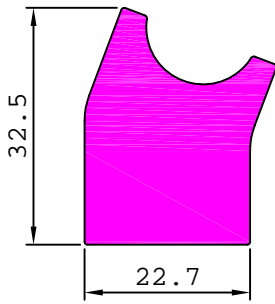

AUTOMOBILE SECTIONS

27893

9.279 kg/m

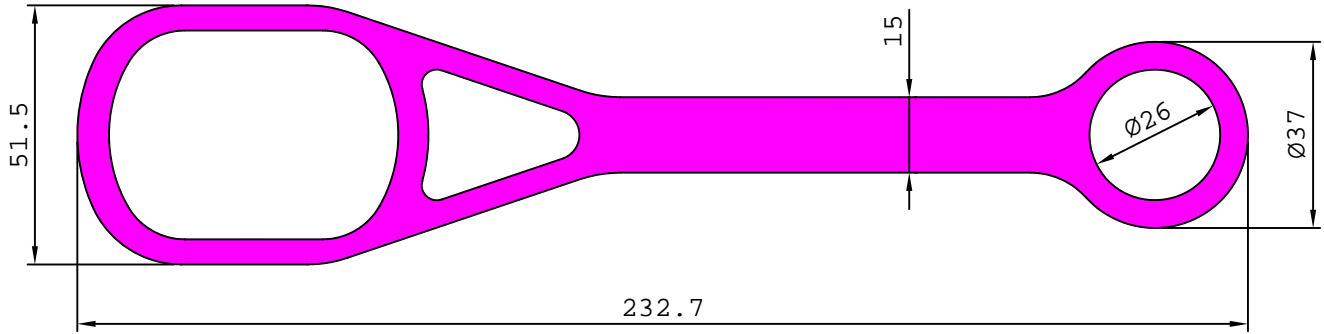

27894

13.445 kg/m

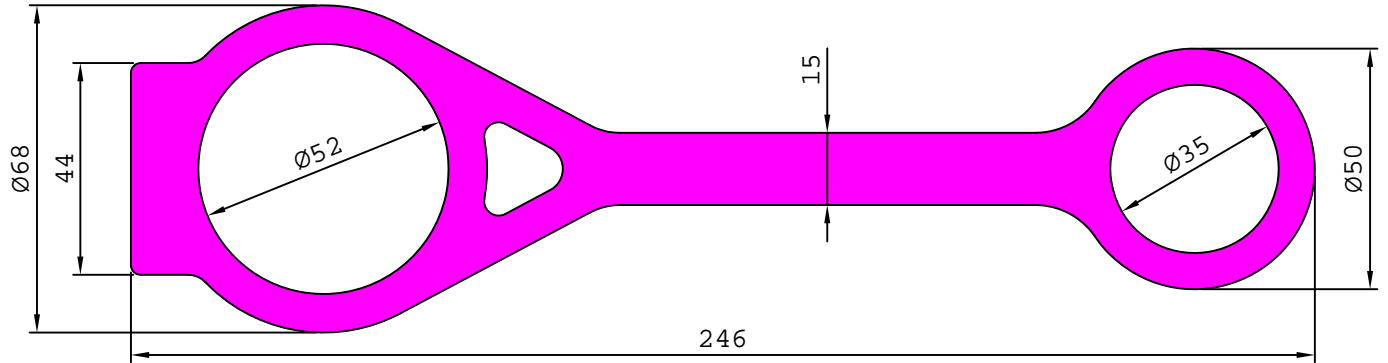

27897

8.293 kg/m

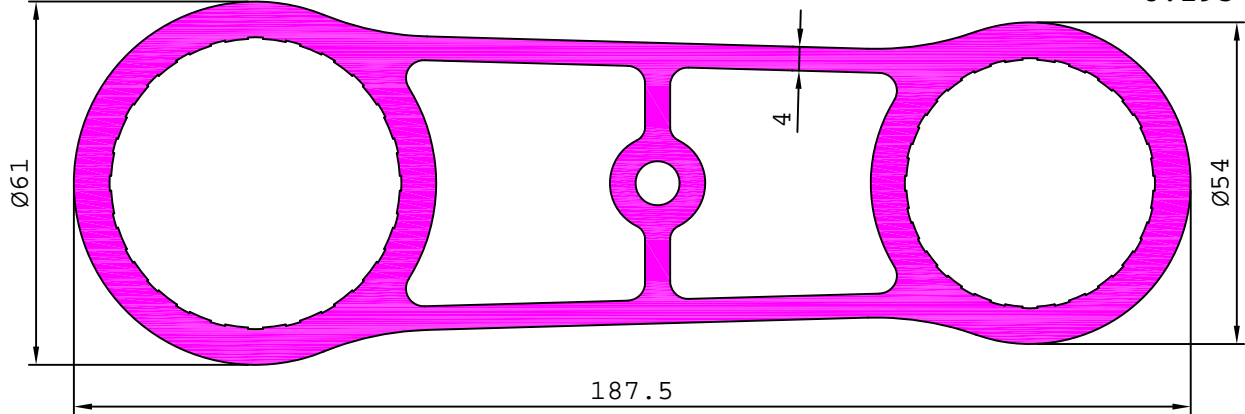

27899

8.700 kg/m

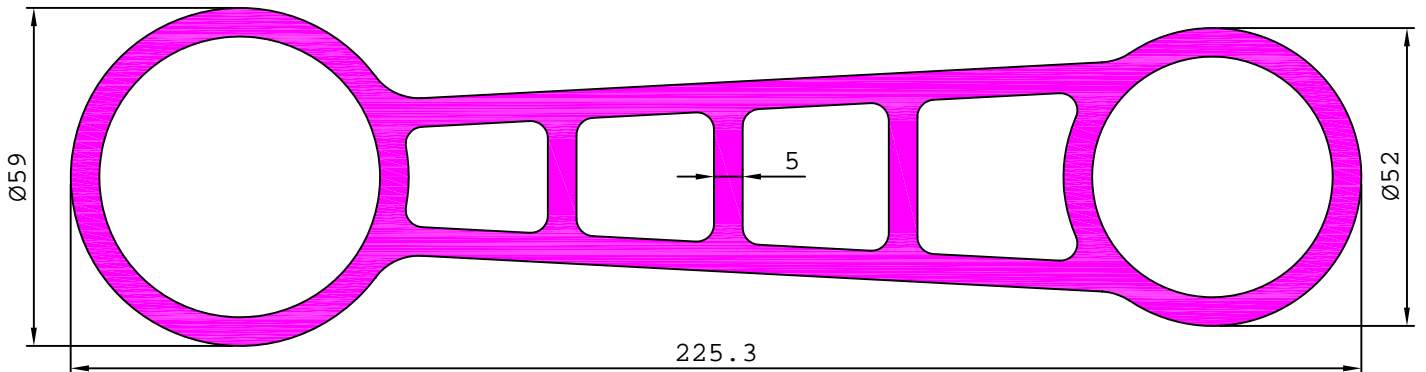

AUTOMOBILE SECTIONS

27860

10.506 kg/m

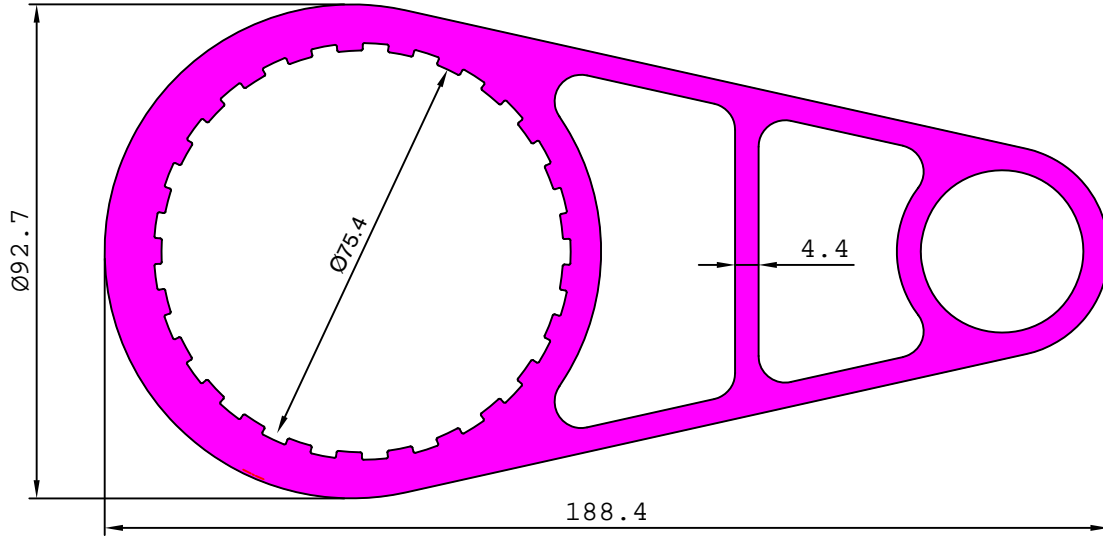

27819

8.092 kg/m

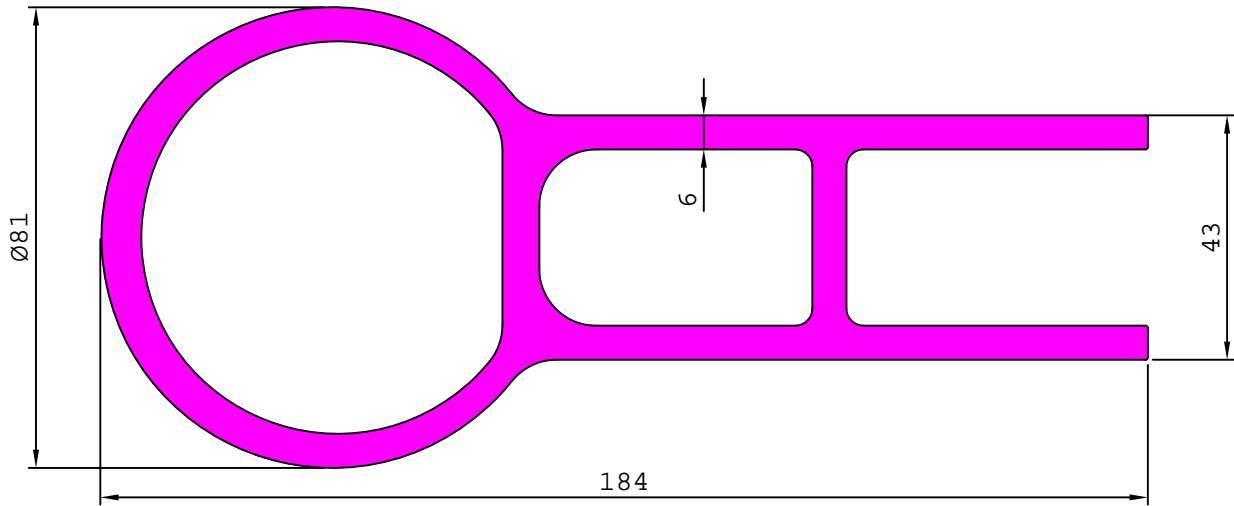

27820

8.643 kg/m

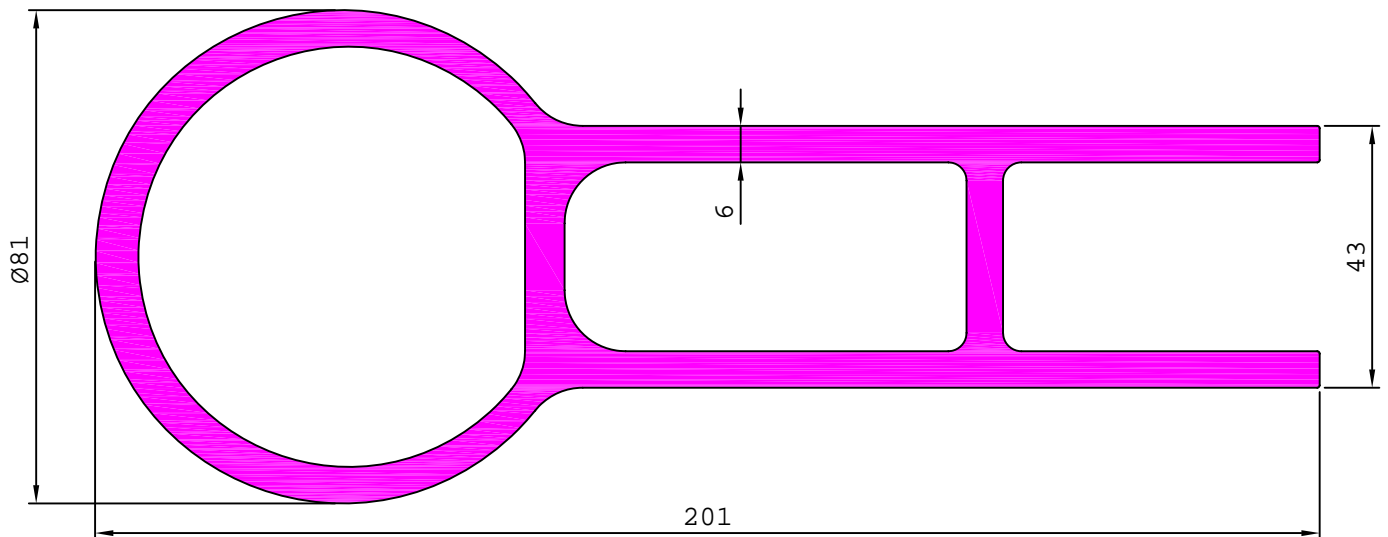

AUTOMOBILE SECTIONS

27942

7.198 kg/m

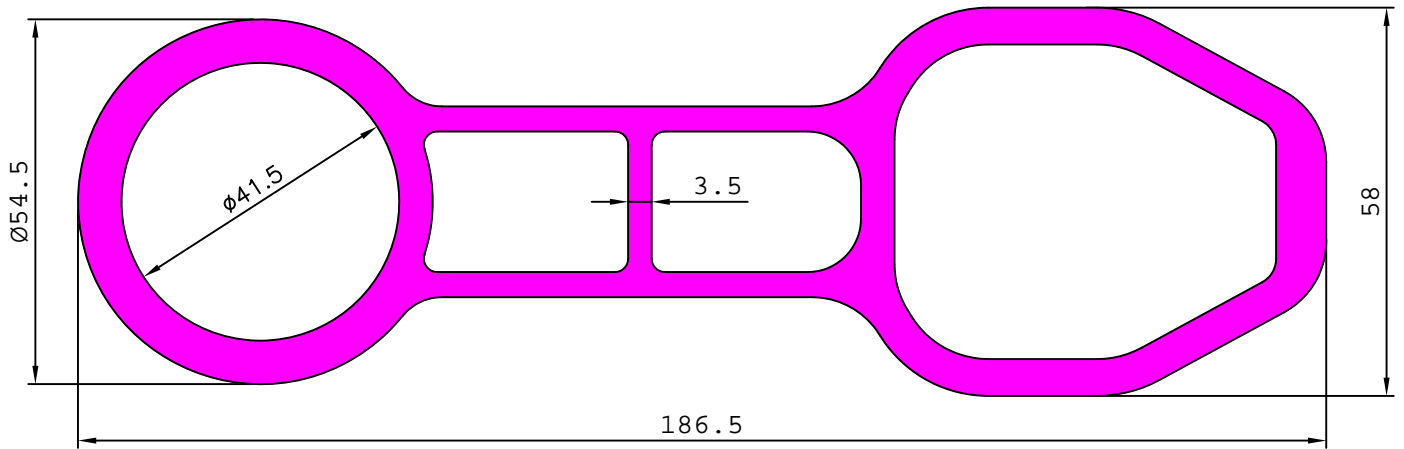

27981

14.844 kg/m

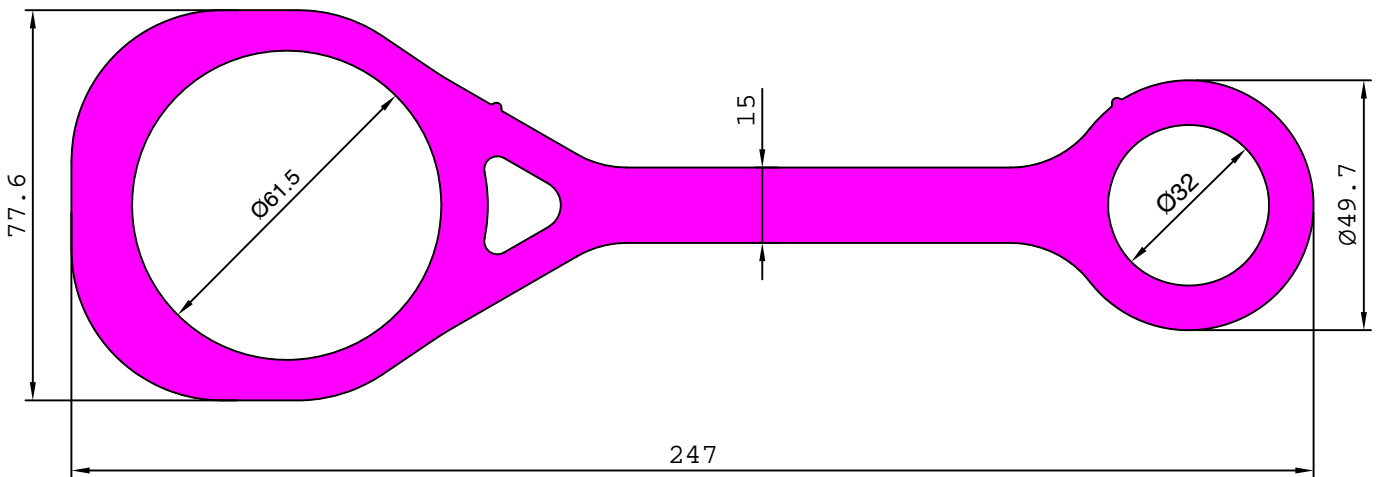

28018

8.423 kg/m

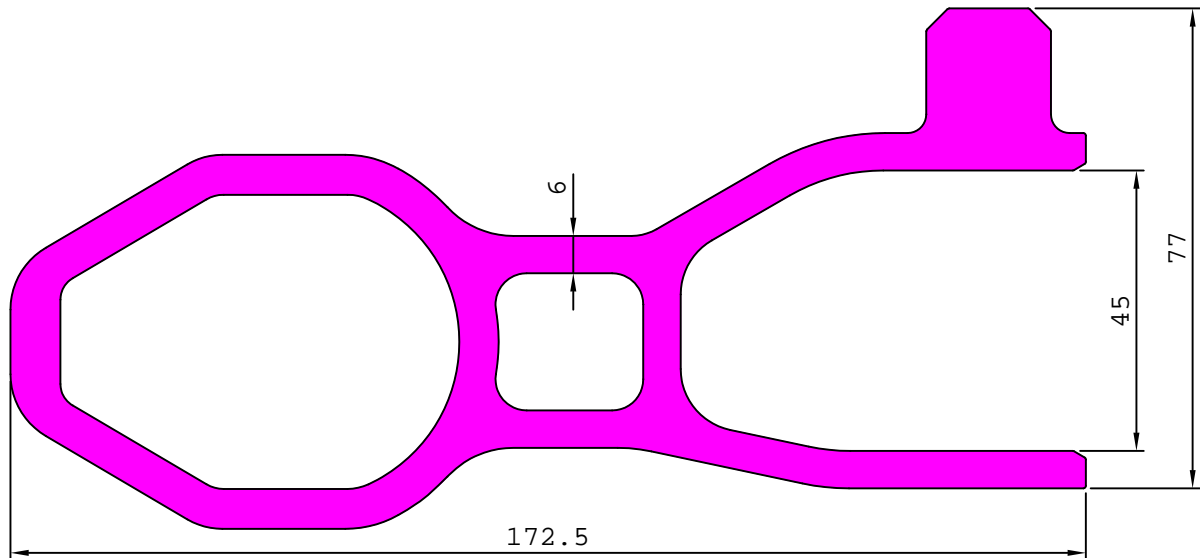

AUTOMOBILE SECTIONS

28034

13.496 kg/m

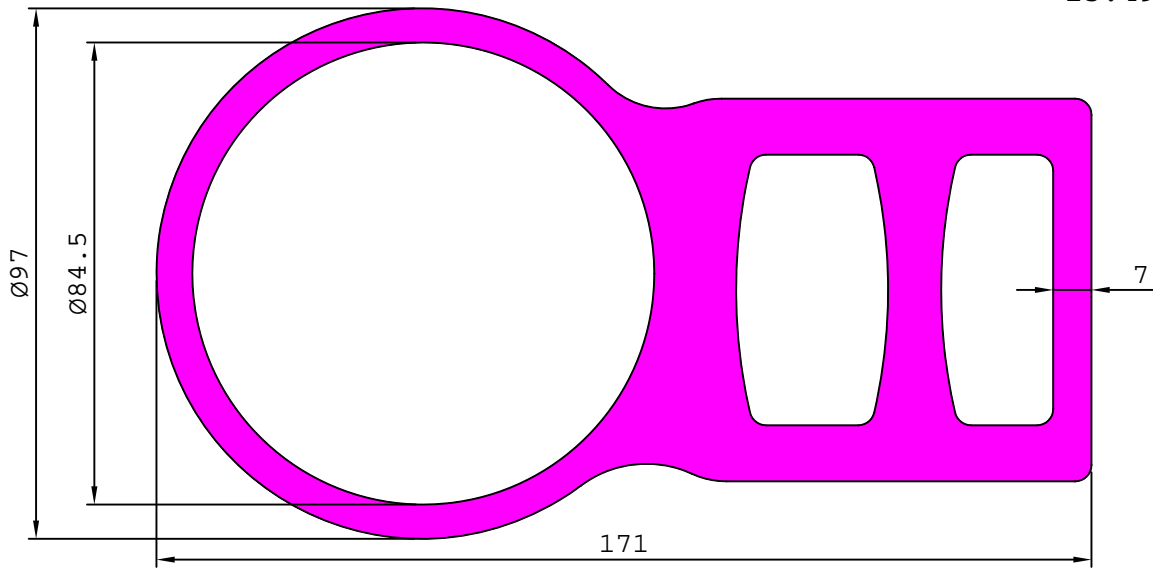

28030

8.370 kg/m

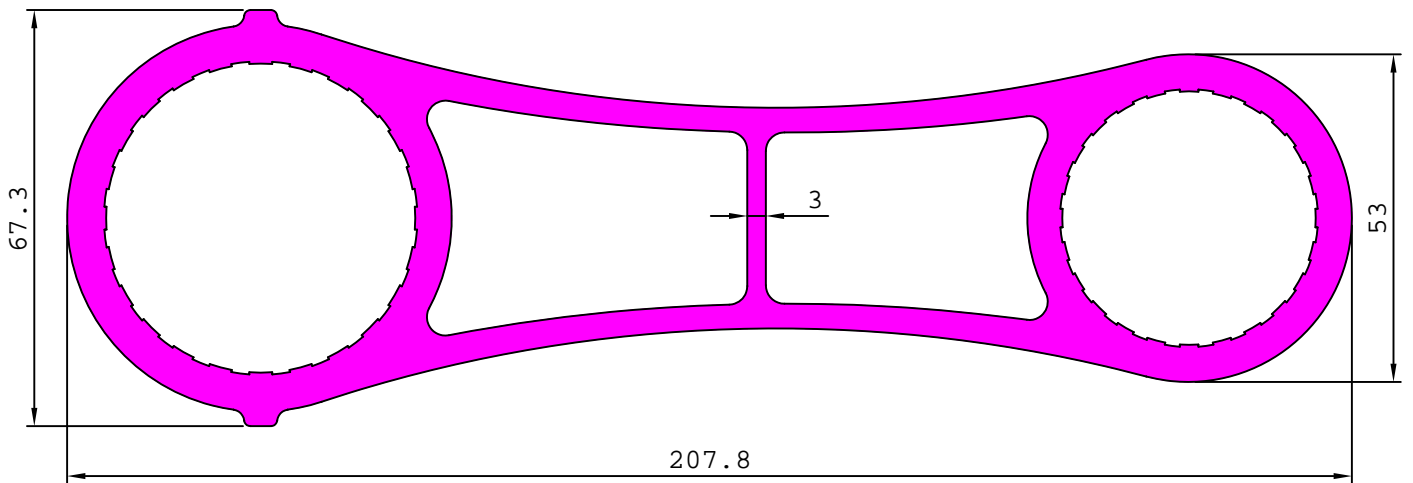

28032

14.882 kg/m

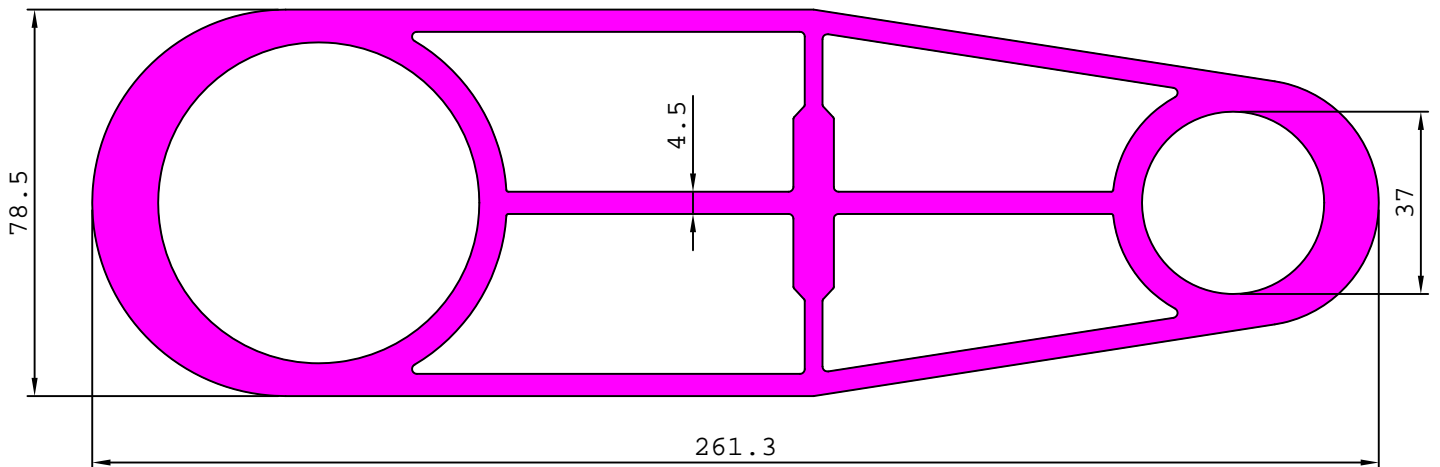

AUTOMOBILE SECTIONS

28135

10.799 kg/m

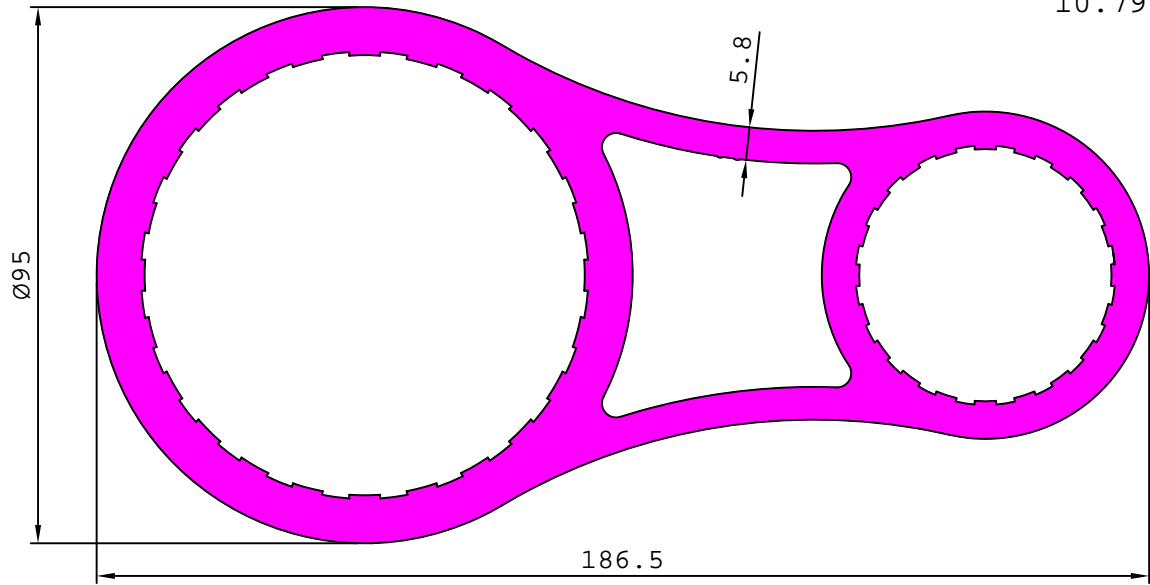

28040

9.371 kg/m

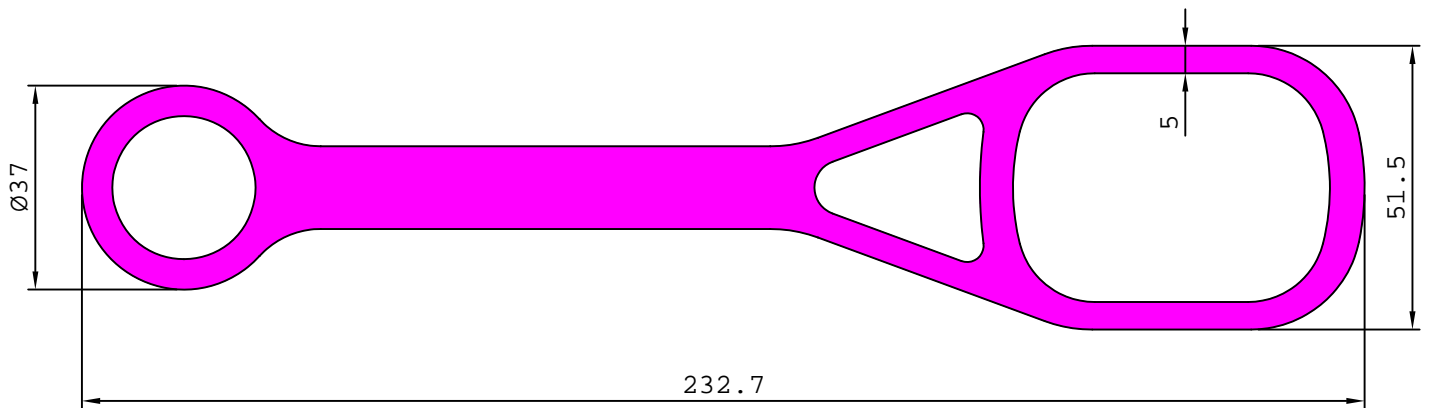

27945

7.272 kg/m

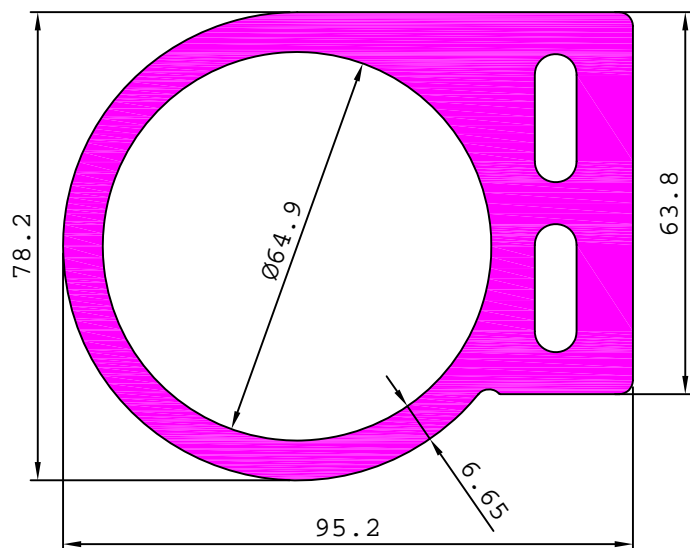

28212

9.137 kg/m

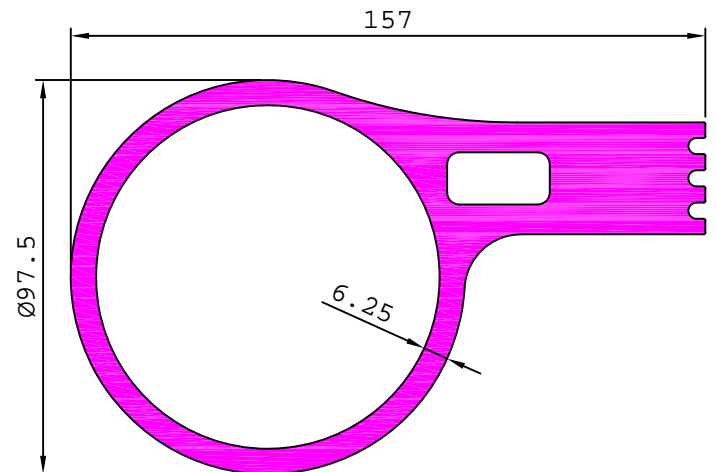

AUTOMOBILE SECTIONS

28183

9.129 kg/m

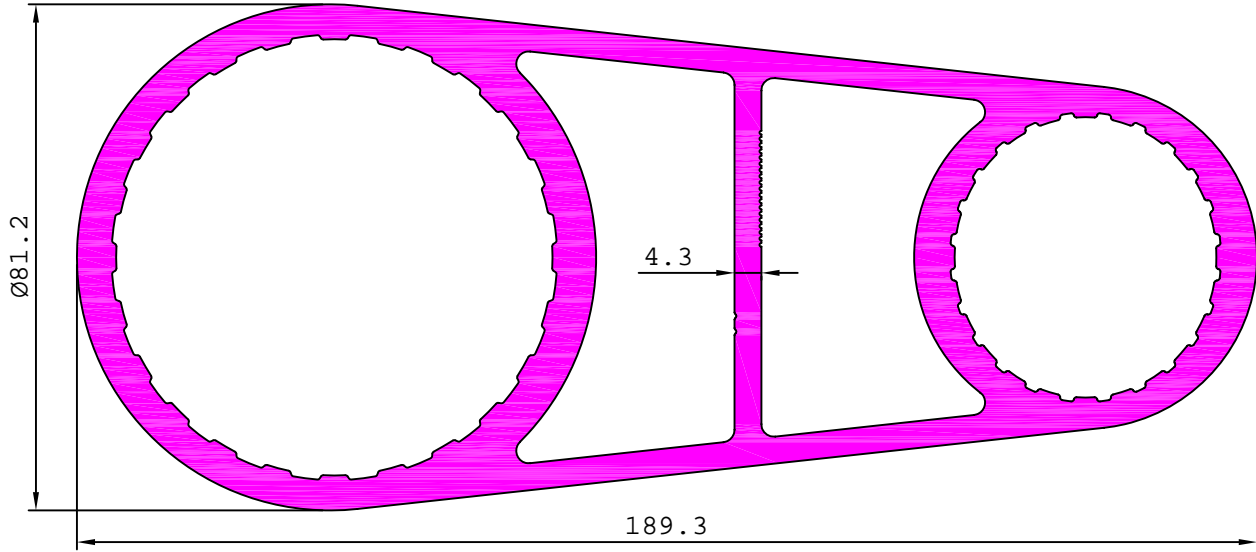

28184

14.681 kg/m

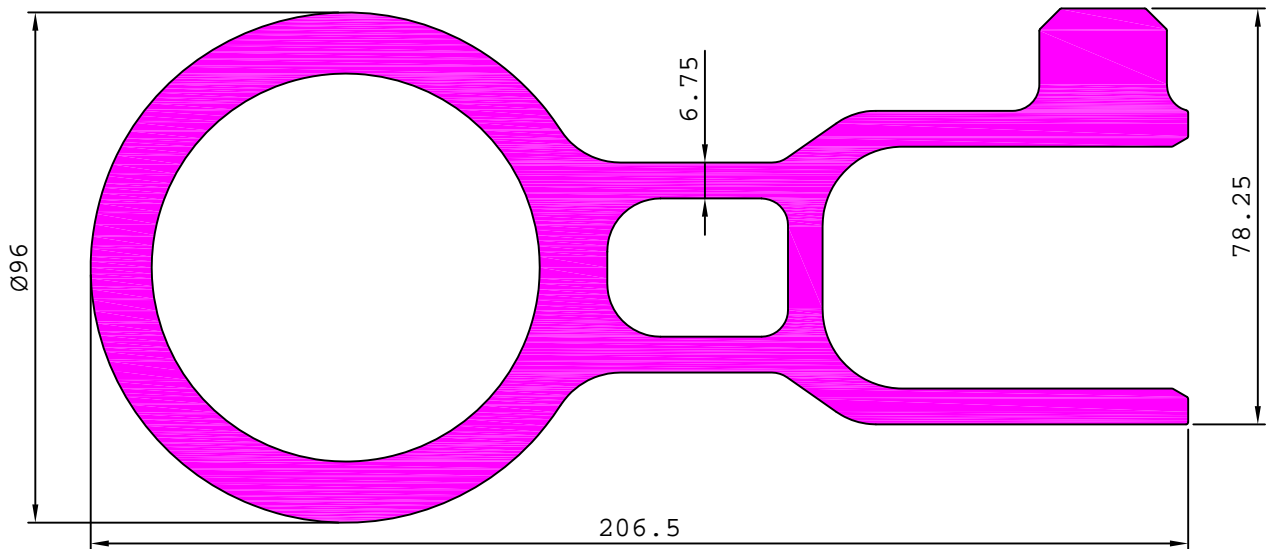

28213

8.900 kg/m

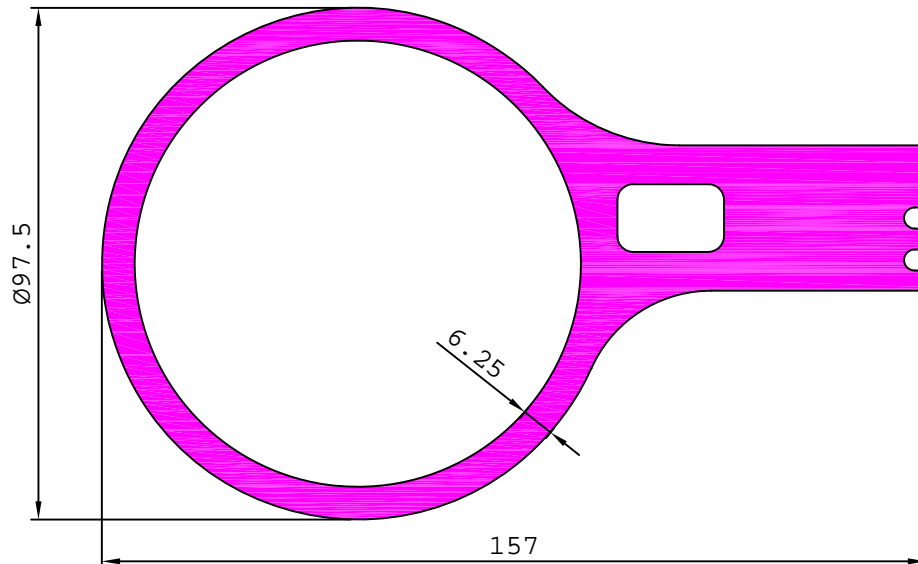



AUTOMOBILE SECTIONS

29311

11.920 kg/m

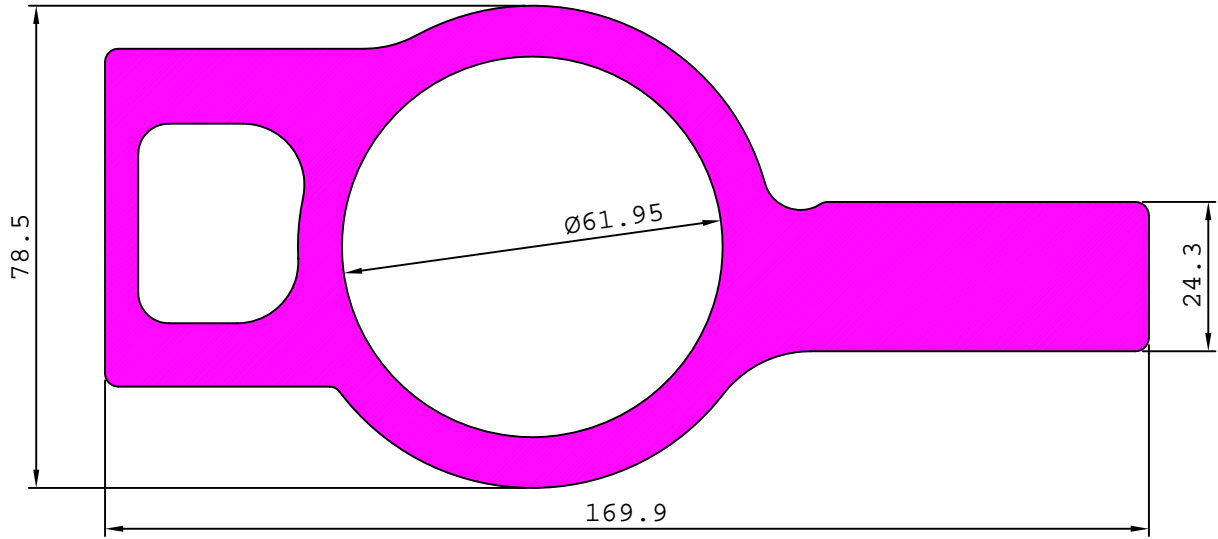

28435

53.710 kg/m

